

EECE 571F: Deep Learning with Structures

Lecture 4: Graph Neural Networks Graph Convolution Models

Renjie Liao

University of British Columbia

Winter, Term 1, 2022

Course Scope

- Brief Intro to Deep Learning
- Geometric Deep Learning
 - Deep Learning Models for Sets and Sequences: Deep Sets & Transformers
 - Deep Learning Models for Graphs: Message Passing & Graph Convolution GNNs
 - Expressiveness & Generalizations of GNNs
 - Unsupervised/Self-supervised Graph Representation Learning
- Probabilistic Deep Learning
 - Deep Generative Models:
Auto-regressive models, GANs, VAEs, Diffusion/Score based models
 - Discrete/Hybrid Latent Variable Models: RBMs, Latent Graph Models
 - Stochastic Gradient Estimation

Course Scope

- Brief Intro to Deep Learning
- Geometric Deep Learning
 - Deep Learning Models for Sets and Sequences: Deep Sets & Transformers
 - Deep Learning Models for Graphs: Message Passing & **Graph Convolution GNNs**
 - Expressiveness & Generalizations of GNNs
 - Unsupervised/Self-supervised Graph Representation Learning
- Probabilistic Deep Learning
 - Deep Generative Models:
Auto-regressive models, GANs, VAEs, Diffusion/Score based models
 - Discrete/Hybrid Latent Variable Models: RBMs, Latent Graph Models
 - Stochastic Gradient Estimation

Deep Learning for Graphs

Graph Neural Networks (GNNs)

- Neural networks that can process general graph structured data
- First proposed in 2008 [1] and dates back to Recursive Neural Networks (mainly processing trees) in 90s [2]
- In fact, Boltzmann Machines [3] (fully connected graphs with binary units) in 80s can be viewed as GNNs
- Most of GNNs (if not all) can be incorporated by the **Message Passing** paradigm
- GNNs have been independently studied in signal processing community under **Graph Signal Processing** [4,5]
- The study of GNNs and other related models are also called **Geometric Deep Learning** [6]

Convolution on Graphs?

- Let us review Fourier Transform and Convolution Theorem

Fourier Transform

Given signal $f(t)$, the classical Fourier transform is:

$$\hat{f}(\xi) = \int_{\mathbb{R}} f(t) e^{-2\pi i \xi t} dt$$

i.e., expansion in terms of complex exponentials

Fourier Transform

Given signal $f(t)$, the classical Fourier transform is:

$$\hat{f}(\xi) = \int_{\mathbb{R}} f(t) e^{-2\pi i \xi t} dt$$

i.e., expansion in terms of complex exponentials

Laplacian operator is: $\Delta f = \nabla^2 f = \frac{\partial^2}{\partial t^2} f$

Fourier Transform

Given signal $f(t)$, the classical Fourier transform is:

$$\hat{f}(\xi) = \int_{\mathbb{R}} f(t) e^{-2\pi i \xi t} dt$$

i.e., expansion in terms of complex exponentials

Laplacian operator is: $\Delta f = \nabla^2 f = \frac{\partial^2}{\partial t^2} f$

We have $\Delta(e^{-2\pi i \xi t}) = \frac{\partial^2}{\partial t^2} e^{-2\pi i \xi t} = -(2\pi \xi)^2 e^{-2\pi i \xi t}$

Fourier Transform

Given signal $f(t)$, the classical Fourier transform is:

$$\hat{f}(\xi) = \int_{\mathbb{R}} f(t) e^{-2\pi i \xi t} dt$$

i.e., expansion in terms of complex exponentials

Laplacian operator is:
$$\Delta f = \nabla^2 f = \frac{\partial^2}{\partial t^2} f$$

We have
$$\Delta(e^{-2\pi i \xi t}) = \frac{\partial^2}{\partial t^2} e^{-2\pi i \xi t} = -(2\pi \xi)^2 e^{-2\pi i \xi t}$$

$e^{-2\pi i \xi t}$ is the eigenfunction of Laplacian operator!

Fourier Transform

Given signal $f(t)$, the classical Fourier transform is:

Inverse Fourier transform

$$\hat{f}(\xi) = \int_{\mathbb{R}} f(t) e^{-2\pi i \xi t} dt \qquad f(t) = \int_{\mathbb{R}} \hat{f}(\xi) e^{2\pi i \xi t} d\xi$$

i.e., expansion in terms of complex exponentials

Laplacian operator is:

$$\Delta f = \nabla^2 f = \frac{\partial^2}{\partial t^2} f$$

We have

$$\Delta(e^{-2\pi i \xi t}) = \frac{\partial^2}{\partial t^2} e^{-2\pi i \xi t} = -(2\pi \xi)^2 e^{-2\pi i \xi t}$$

$e^{-2\pi i \xi t}$ is the eigenfunction of Laplacian operator!

Convolution

Given signal $f(t)$, filter $h(t)$, the convolution is defined as:

$$(f * h)(t) = \int_{\mathbb{R}} f(\tau)h(t - \tau)d\tau$$

Convolution

Given signal $f(t)$, filter $h(t)$, the convolution is defined as:

$$(f * h)(t) = \int_{\mathbb{R}} f(\tau)h(t - \tau)d\tau$$

Convolution Theorem tells us that

$$(f * h)(t) = \int_{\mathbb{R}} f(\tau)h(t - \tau)d\tau = \int_{\mathbb{R}} \hat{f}(\xi)\hat{h}(\xi)e^{2\pi i\xi t}d\xi$$

where $\hat{f}(\xi) = \int_{\mathbb{R}} f(t)e^{-2\pi i\xi t}dt$ and $\hat{h}(\xi) = \int_{\mathbb{R}} h(t)e^{-2\pi i\xi t}dt$

Convolution

Given signal $f(t)$, filter $h(t)$, the convolution is defined as:

$$(f * h)(t) = \int_{\mathbb{R}} f(\tau)h(t - \tau)d\tau$$

How can we generalize
them to graphs?

Convolution Theorem tells us that

$$(f * h)(t) = \int_{\mathbb{R}} f(\tau)h(t - \tau)d\tau = \int_{\mathbb{R}} \hat{f}(\xi)\hat{h}(\xi)e^{2\pi i\xi t}d\xi$$

where $\hat{f}(\xi) = \int_{\mathbb{R}} f(t)e^{-2\pi i\xi t}dt$ and $\hat{h}(\xi) = \int_{\mathbb{R}} h(t)e^{-2\pi i\xi t}dt$

Convolution on Graphs?

- Let us review Fourier Transform and Convolution Theorem
 1. Based on the *eigenfunction of Laplacian operator*, we define Fourier transform
 2. Based on the convolution theorem, we can define convolution in Fourier domain

Convolution on Graphs?

- Let us review Fourier Transform and Convolution Theorem
 1. Based on the *eigenfunction of Laplacian operator*, we define Fourier transform
 2. Based on the convolution theorem, we can define convolution in Fourier domain
- How can we generalize convolution to graphs?
 1. What is the Laplacian operator on graph?
 2. How can we define convolution in (graph) Fourier domain?

Graph Signal

Graph $G = (V, E)$, graph signal (node feature) X

G

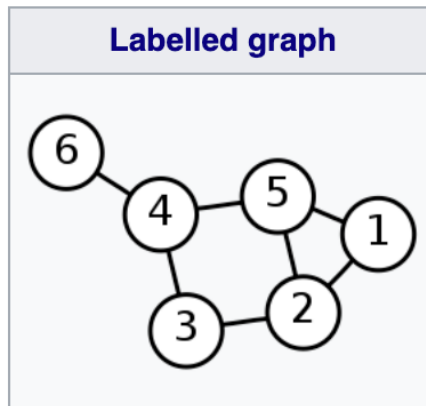

A

Adjacency matrix
$\begin{pmatrix} 0 & 1 & 0 & 0 & 1 & 0 \\ 1 & 0 & 1 & 0 & 1 & 0 \\ 0 & 1 & 0 & 1 & 0 & 0 \\ 0 & 0 & 1 & 0 & 1 & 1 \\ 1 & 1 & 0 & 1 & 0 & 0 \\ 0 & 0 & 0 & 1 & 0 & 0 \end{pmatrix}$

Graph Laplacian

Graph $G = (V, E)$, graph signal (node feature) X

Degree matrix: $D_{ii} = \sum_{j=1}^N A_{ij}$

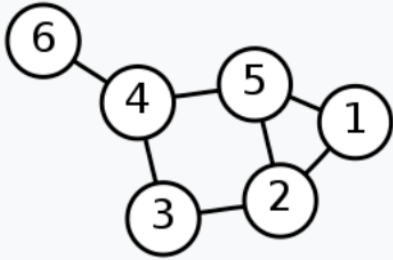
G	D	A
Labelled graph	Degree matrix	Adjacency matrix
	$\begin{pmatrix} 2 & 0 & 0 & 0 & 0 & 0 \\ 0 & 3 & 0 & 0 & 0 & 0 \\ 0 & 0 & 2 & 0 & 0 & 0 \\ 0 & 0 & 0 & 3 & 0 & 0 \\ 0 & 0 & 0 & 0 & 3 & 0 \\ 0 & 0 & 0 & 0 & 0 & 1 \end{pmatrix}$	$\begin{pmatrix} 0 & 1 & 0 & 0 & 1 & 0 \\ 1 & 0 & 1 & 0 & 1 & 0 \\ 0 & 1 & 0 & 1 & 0 & 0 \\ 0 & 0 & 1 & 0 & 1 & 1 \\ 1 & 1 & 0 & 1 & 0 & 0 \\ 0 & 0 & 0 & 1 & 0 & 0 \end{pmatrix}$

Graph Laplacian

Graph $G = (V, E)$, graph signal (node feature) X

Degree matrix: $D_{ii} = \sum_{j=1}^N A_{ij}$

(Combinatorial) Graph Laplacian: $L = D - A$

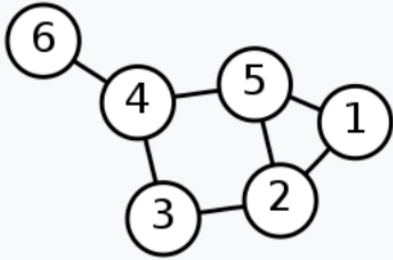
G	D	A	$L = D - A$
Labelled graph	Degree matrix	Adjacency matrix	Laplacian matrix
	$\begin{pmatrix} 2 & 0 & 0 & 0 & 0 & 0 \\ 0 & 3 & 0 & 0 & 0 & 0 \\ 0 & 0 & 2 & 0 & 0 & 0 \\ 0 & 0 & 0 & 3 & 0 & 0 \\ 0 & 0 & 0 & 0 & 3 & 0 \\ 0 & 0 & 0 & 0 & 0 & 1 \end{pmatrix}$	$\begin{pmatrix} 0 & 1 & 0 & 0 & 1 & 0 \\ 1 & 0 & 1 & 0 & 1 & 0 \\ 0 & 1 & 0 & 1 & 0 & 0 \\ 0 & 0 & 1 & 0 & 1 & 1 \\ 1 & 1 & 0 & 1 & 0 & 0 \\ 0 & 0 & 0 & 1 & 0 & 0 \end{pmatrix}$	$\begin{pmatrix} 2 & -1 & 0 & 0 & -1 & 0 \\ -1 & 3 & -1 & 0 & -1 & 0 \\ 0 & -1 & 2 & -1 & 0 & 0 \\ 0 & 0 & -1 & 3 & -1 & -1 \\ -1 & -1 & 0 & -1 & 3 & 0 \\ 0 & 0 & 0 & -1 & 0 & 1 \end{pmatrix}$

Graph Laplacian

Graph $G = (V, E)$, graph signal (node feature) X

Degree matrix: $D_{ii} = \sum_{j=1}^N A_{ij}$

(Combinatorial) Graph Laplacian: $L = D - A$

Compute difference between current node and its neighbors!

G	D	A	$L = D - A$
Labelled graph	Degree matrix	Adjacency matrix	Laplacian matrix
	$\begin{pmatrix} 2 & 0 & 0 & 0 & 0 & 0 \\ 0 & 3 & 0 & 0 & 0 & 0 \\ 0 & 0 & 2 & 0 & 0 & 0 \\ 0 & 0 & 0 & 3 & 0 & 0 \\ 0 & 0 & 0 & 0 & 3 & 0 \\ 0 & 0 & 0 & 0 & 0 & 1 \end{pmatrix}$	$\begin{pmatrix} 0 & 1 & 0 & 0 & 1 & 0 \\ 1 & 0 & 1 & 0 & 1 & 0 \\ 0 & 1 & 0 & 1 & 0 & 0 \\ 0 & 0 & 1 & 0 & 1 & 1 \\ 1 & 1 & 0 & 1 & 0 & 0 \\ 0 & 0 & 0 & 1 & 0 & 0 \end{pmatrix}$	$\begin{pmatrix} 2 & -1 & 0 & 0 & -1 & 0 \\ -1 & 3 & -1 & 0 & -1 & 0 \\ 0 & -1 & 2 & -1 & 0 & 0 \\ 0 & 0 & -1 & 3 & -1 & -1 \\ -1 & -1 & 0 & -1 & 3 & 0 \\ 0 & 0 & 0 & -1 & 0 & 1 \end{pmatrix}$

Graph Laplacian

For undirected graphs, (Combinatorial) Graph Laplacian:

- Symmetric
- Diagonally dominant
- Positive semi-definite (PSD)
- The number of connected components in the graph the algebraic multiplicity of the 0 eigenvalue.

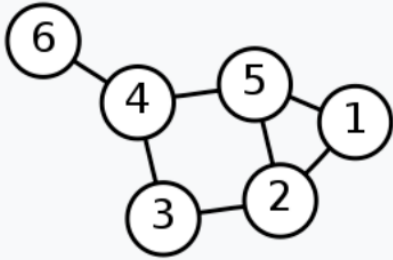
G	D	A	$L = D - A$
Labelled graph	Degree matrix	Adjacency matrix	Laplacian matrix
	$\begin{pmatrix} 2 & 0 & 0 & 0 & 0 & 0 \\ 0 & 3 & 0 & 0 & 0 & 0 \\ 0 & 0 & 2 & 0 & 0 & 0 \\ 0 & 0 & 0 & 3 & 0 & 0 \\ 0 & 0 & 0 & 0 & 3 & 0 \\ 0 & 0 & 0 & 0 & 0 & 1 \end{pmatrix}$	$\begin{pmatrix} 0 & 1 & 0 & 0 & 1 & 0 \\ 1 & 0 & 1 & 0 & 1 & 0 \\ 0 & 1 & 0 & 1 & 0 & 0 \\ 0 & 0 & 1 & 0 & 1 & 1 \\ 1 & 1 & 0 & 1 & 0 & 0 \\ 0 & 0 & 0 & 1 & 0 & 0 \end{pmatrix}$	$\begin{pmatrix} 2 & -1 & 0 & 0 & -1 & 0 \\ -1 & 3 & -1 & 0 & -1 & 0 \\ 0 & -1 & 2 & -1 & 0 & 0 \\ 0 & 0 & -1 & 3 & -1 & -1 \\ -1 & -1 & 0 & -1 & 3 & 0 \\ 0 & 0 & 0 & -1 & 0 & 1 \end{pmatrix}$

Graph Laplacian

Symmetrically Normalized Graph Laplacian:

$$L = D^{-\frac{1}{2}}(D - A)D^{-\frac{1}{2}} = I - D^{-\frac{1}{2}}AD^{-\frac{1}{2}}$$

Eigenvalues lie in $[0, 2]$, why? (Try to show it by yourself!)

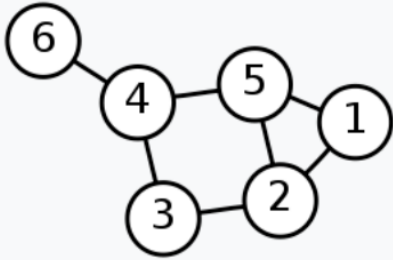
G	D	A	$L = D - A$
Labelled graph	Degree matrix	Adjacency matrix	Laplacian matrix
	$\begin{pmatrix} 2 & 0 & 0 & 0 & 0 & 0 \\ 0 & 3 & 0 & 0 & 0 & 0 \\ 0 & 0 & 2 & 0 & 0 & 0 \\ 0 & 0 & 0 & 3 & 0 & 0 \\ 0 & 0 & 0 & 0 & 3 & 0 \\ 0 & 0 & 0 & 0 & 0 & 1 \end{pmatrix}$	$\begin{pmatrix} 0 & 1 & 0 & 0 & 1 & 0 \\ 1 & 0 & 1 & 0 & 1 & 0 \\ 0 & 1 & 0 & 1 & 0 & 0 \\ 0 & 0 & 1 & 0 & 1 & 1 \\ 1 & 1 & 0 & 1 & 0 & 0 \\ 0 & 0 & 0 & 1 & 0 & 0 \end{pmatrix}$	$\begin{pmatrix} 2 & -1 & 0 & 0 & -1 & 0 \\ -1 & 3 & -1 & 0 & -1 & 0 \\ 0 & -1 & 2 & -1 & 0 & 0 \\ 0 & 0 & -1 & 3 & -1 & -1 \\ -1 & -1 & 0 & -1 & 3 & 0 \\ 0 & 0 & 0 & -1 & 0 & 1 \end{pmatrix}$

Spectral Theorem

If L is a symmetric matrix, we have

$$L = U\Lambda U^\top = \sum_{i=1}^N \lambda_i \mathbf{u}_i \mathbf{u}_i^\top$$

where $U = [\mathbf{u}_1, \mathbf{u}_2, \dots, \mathbf{u}_N]$ contains eigenvectors of L and is orthogonal $UU^\top = U^\top U = I$

$$\Lambda = \begin{bmatrix} \lambda_1 & & & \\ & \lambda_2 & & \\ & & \ddots & \\ & & & \lambda_N \end{bmatrix} \text{ contains the eigenvalues of } L$$

Spectral Theorem

If L is a symmetric matrix, we have

Spectral Decomposition

$$L = U\Lambda U^\top = \sum_{i=1}^N \lambda_i \mathbf{u}_i \mathbf{u}_i^\top$$

where $U = [\mathbf{u}_1, \mathbf{u}_2, \dots, \mathbf{u}_N]$ contains eigenvectors of L and is orthogonal $UU^\top = U^\top U = I$

$$\Lambda = \begin{bmatrix} \lambda_1 & & & \\ & \lambda_2 & & \\ & & \ddots & \\ & & & \lambda_N \end{bmatrix} \text{ contains the eigenvalues of } L$$

Graph Fourier Transform

Given signal $f(t)$, the *classical Fourier transform* is:

$$\hat{f}(\xi) = \int_{\mathbb{R}} f(t) e^{-2\pi i \xi t} dt$$

i.e., expansion in terms of complex exponentials (**eigenfunction of Laplacian operator**)

Graph Fourier Transform

Given signal $f(t)$, the *classical Fourier transform* is:

$$\hat{f}(\xi) = \int_{\mathbb{R}} f(t) e^{-2\pi i \xi t} dt$$

i.e., expansion in terms of complex exponentials (**eigenfunction of Laplacian operator**)

Given graph signal $X \in \mathbb{R}^{N \times 1}$, the *Graph Fourier Transform* is:

$$\hat{X}[i] = \sum_{j=1}^N U[j, i] X[j]$$

$$\hat{X} = U^{\top} X$$

i.e., expansion in terms of **eigenvectors of Graph Laplacian operator**

Graph Fourier Transform

Given signal $f(t)$, the *classical Fourier transform* is:

$$\hat{f}(\xi) = \int_{\mathbb{R}} f(t) e^{-2\pi i \xi t} dt$$

i.e., expansion in terms of complex exponentials (**eigenfunction of Laplacian operator**)

Given graph signal $X \in \mathbb{R}^{N \times 1}$, the *Graph Fourier Transform* is:

Inverse Graph Fourier Transform

$$\hat{X}[i] = \sum_{j=1}^N U[j, i] X[j]$$

$$\hat{X} = U^{\top} X$$

$$X = U \hat{X}$$

i.e., expansion in terms of **eigenvectors of Graph Laplacian operator**

Graph Fourier Transform

Given signal $f(t)$, the *classical Fourier transform* is:

$$\hat{f}(\xi) = \int_{\mathbb{R}} f(t) e^{-2\pi i \xi t} dt$$

i.e., expansion in terms of complex exponentials (**eigenfunction of Laplacian operator**)

Given graph signal $X \in \mathbb{R}^{N \times 1}$, the *Graph Fourier Transform* is:

Inverse Graph Fourier Transform

$$\hat{X}[i] = \sum_{j=1}^N U[j, i] X[j]$$

Eigenvalue corresponds to frequency!

$$\hat{X} = U^{\top} X$$

$$X = U \hat{X}$$

i.e., expansion in terms of **eigenvectors of Graph Laplacian operator**

Graph Convolution (Spectral Filtering)

Convolution:

$$(f * h)(t) = \int_{\mathbb{R}} f(\tau)h(t - \tau)d\tau = \int_{\mathbb{R}} \hat{f}(\xi)\hat{h}(\xi)e^{2\pi i\xi t} d\xi$$

Graph Convolution (Spectral Filtering)

Convolution:

$$(f * h)(t) = \int_{\mathbb{R}} f(\tau)h(t - \tau)d\tau = \int_{\mathbb{R}} \hat{f}(\xi)\hat{h}(\xi)e^{2\pi i\xi t}d\xi$$

Graph Fourier Transform:

$$\hat{X} = U^{\top} X \qquad L = U \Lambda U^{\top}$$

Graph Convolution (Spectral Filtering)

Convolution:

$$(f * h)(t) = \int_{\mathbb{R}} f(\tau)h(t - \tau)d\tau = \int_{\mathbb{R}} \hat{f}(\xi)\hat{h}(\xi)e^{2\pi i\xi t}d\xi$$

Graph Fourier Transform:

$$\hat{X} = U^{\top} X \quad L = U \Lambda U^{\top}$$

Graph Convolution in Fourier domain (Spectral Filtering):

$$h_{\theta} * X = U h_{\theta}(\Lambda) U^{\top} X$$

Spectral Filters

Graph Convolution in Fourier domain (Spectral Filtering):

$$h_{\theta} * X = U h_{\theta}(\Lambda) U^{\top} X$$

Directly construct h requires spectral decomposition which is $O(N^3)$!

Spectral Filters

Graph Convolution in Fourier domain (Spectral Filtering):

$$h_{\theta} * X = U h_{\theta}(\Lambda) U^{\top} X$$

Directly construct h requires spectral decomposition which is $O(N^3)$!

Can we find some efficient construction of h ?

Spectral Filters

Graph Convolution in Fourier domain (Spectral Filtering):

$$h_{\theta} * X = U h_{\theta}(\Lambda) U^{\top} X$$

Directly construct h requires spectral decomposition which is $O(N^3)$!

Can we find some efficient construction of h ?

- Chebyshev polynomials [7]
- Graph wavelets [7]

Chebyshev Polynomials

Chebyshev polynomials of the first kind:

$$T_0(x) = 1$$

$$T_1(x) = x$$

$$T_{n+1}(x) = 2xT_n(x) - T_{n-1}(x)$$

Chebyshev Polynomials

Chebyshev polynomials of the first kind:

$$T_0(x) = 1$$

$$T_1(x) = x$$

$$T_{n+1}(x) = 2xT_n(x) - T_{n-1}(x)$$

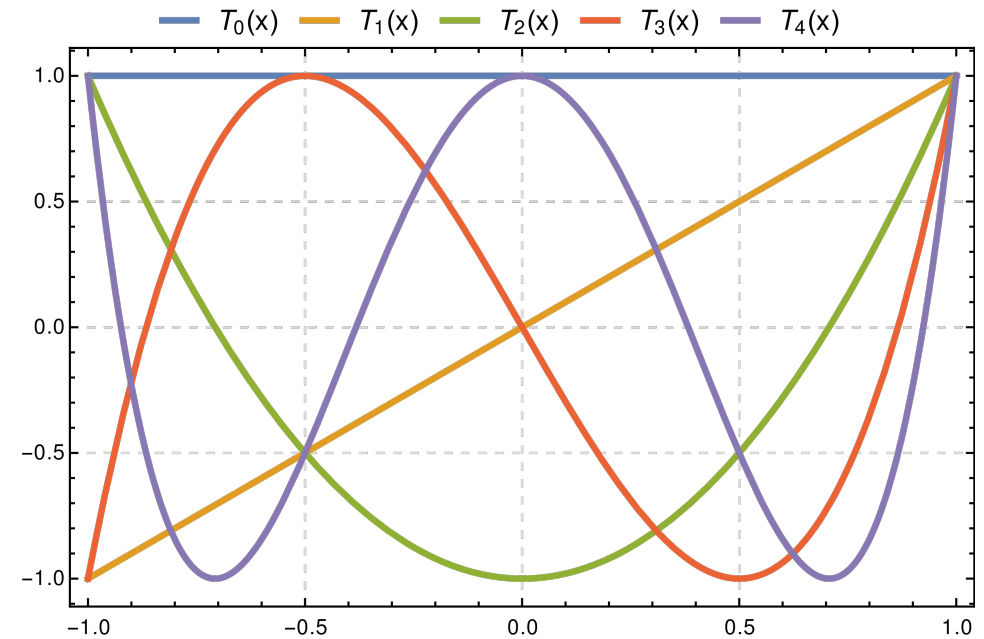

Chebyshev Polynomials

Chebyshev polynomials of the first kind:

$$T_0(x) = 1$$

$$T_1(x) = x$$

$$T_{n+1}(x) = 2xT_n(x) - T_{n-1}(x)$$

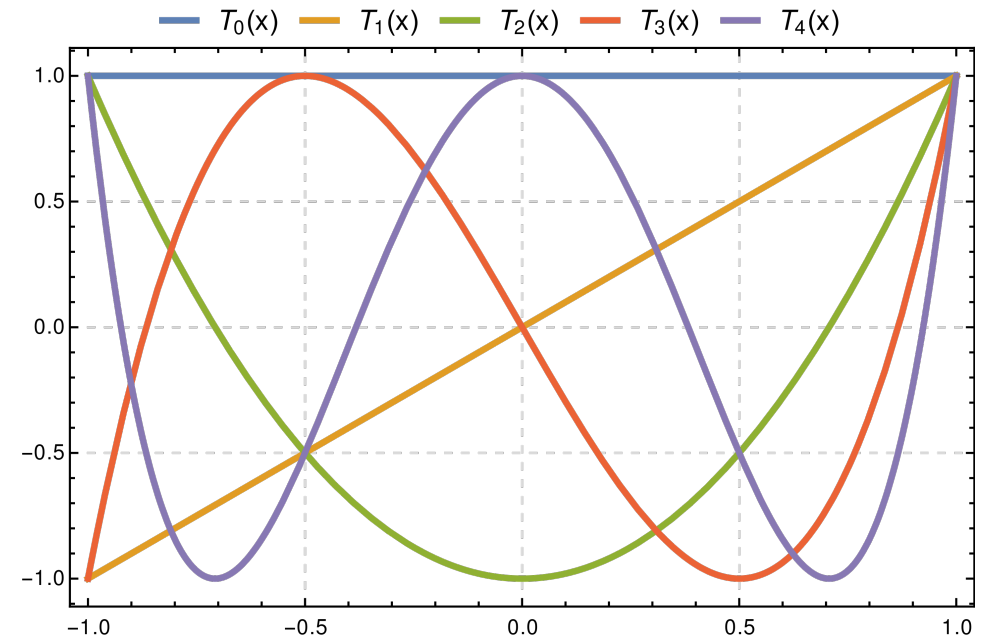

They provide orthonormal basis in some Sobolev space on $[-1, 1]$:

$$h(x) = \sum_{n=0}^{\infty} a_n T_n(x)$$

Chebyshev Polynomials

Chebyshev polynomials of the first kind:

$$T_0(x) = 1$$

$$T_1(x) = x$$

$$T_{n+1}(x) = 2xT_n(x) - T_{n-1}(x)$$

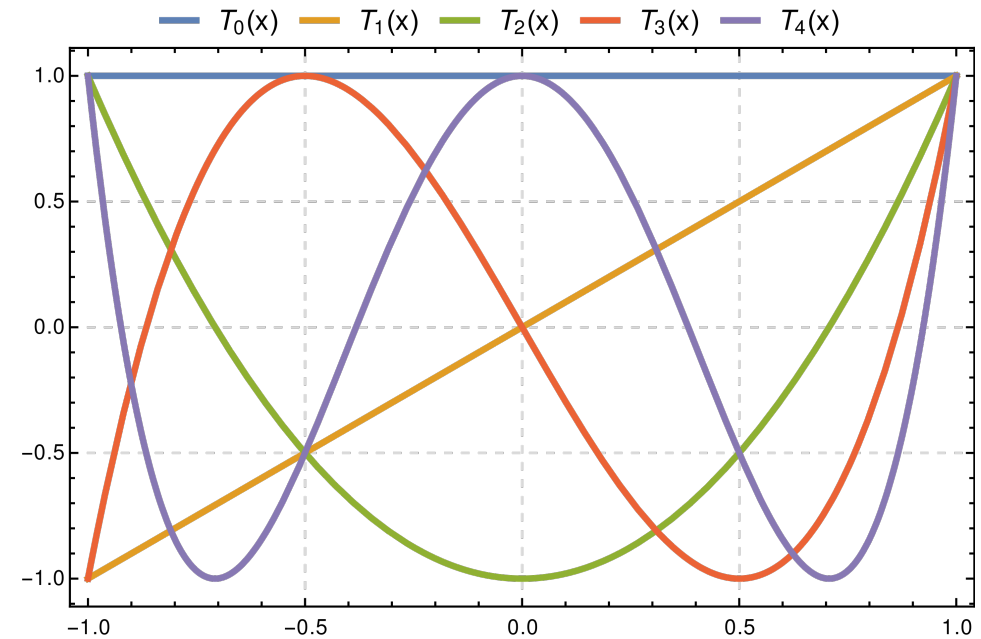

They provide orthonormal basis in some Sobolev space on $[-1, 1]$:

$$h(x) = \sum_{n=0}^{\infty} a_n T_n(x)$$

$$\int_{-1}^1 T_n(x) T_m(x) \frac{dx}{\sqrt{1-x^2}} = \begin{cases} 0 & \text{if } n \neq m \\ \pi & \text{if } n = m = 0 \\ \frac{\pi}{2} & \text{if } n = m \neq 0 \end{cases}$$

Spectral Filters

Chebyshev expansion:

$$h(x) = \sum_{n=0}^{\infty} a_n T_n(x)$$

Spectral Filters

Chebyshev expansion:

$$h(x) = \sum_{n=0}^{\infty} a_n T_n(x)$$

Spectral filtering:

$$h_{\theta} * X = U h_{\theta}(\Lambda) U^{\top} X$$

Spectral Filters

Chebyshev expansion:

$$h(x) = \sum_{n=0}^{\infty} a_n T_n(x)$$

Spectral filtering:

$$h_{\theta} * X = U h_{\theta}(\Lambda) U^{\top} X$$

Truncated Chebyshev polynomials approximation:

$$h_{\theta}(\Lambda) \approx \sum_{n=0}^K \theta_n T_n(\tilde{\Lambda}) = \sum_{n=0}^K \theta_n T_n\left(\frac{2\Lambda}{\lambda_{\max}} - I\right)$$

Spectral Filters

Truncated Chebyshev polynomials approximation:

$$h_{\theta}(\Lambda) \approx \sum_{n=0}^K \theta_n T_n(\tilde{\Lambda}) = \sum_{n=0}^K \theta_n T_n\left(\frac{2\Lambda}{\lambda_{\max}} - I\right)$$

Graph Convolution:

$$h_{\theta} * X = U h_{\theta}(\Lambda) U^{\top} X$$

Spectral Filters

Truncated Chebyshev polynomials approximation:

$$h_{\theta}(\Lambda) \approx \sum_{n=0}^K \theta_n T_n(\tilde{\Lambda}) = \sum_{n=0}^K \theta_n T_n\left(\frac{2\Lambda}{\lambda_{\max}} - I\right)$$

Graph Convolution:

$$h_{\theta} * X = U h_{\theta}(\Lambda) U^{\top} X$$

Truncated Chebyshev polynomials based Graph Convolution:

$$\begin{aligned} h_{\theta} * X &= U h_{\theta}(\Lambda) U^{\top} X \\ &\approx U \left(\sum_{n=0}^K \theta_n T_n\left(\frac{2\Lambda}{\lambda_{\max}} - I\right) \right) U^{\top} X \end{aligned}$$

Spectral Filters

Recall we do not want explicit spectral decomposition since it is expensive!

$$h_\theta * X \approx U \left(\sum_{n=0}^K \theta_n T_n \left(\frac{2\Lambda}{\lambda_{\max}} - I \right) \right) U^\top X$$

Spectral Filters

Recall we do not want explicit spectral decomposition since it is expensive!

$$h_\theta * X \approx U \left(\sum_{n=0}^K \theta_n T_n \left(\frac{2\Lambda}{\lambda_{\max}} - I \right) \right) U^\top X$$

Are Chebyshev polynomials efficient?

Spectral Filters

Recall

$$T_0(x) = 1$$

$$T_1(x) = x$$

$$T_{n+1}(x) = 2xT_n(x) - T_{n-1}(x)$$

Spectral Filters

Recall

$$T_0(x) = 1$$

$$T_1(x) = x$$

$$T_{n+1}(x) = 2xT_n(x) - T_{n-1}(x)$$

Let

$$T_n(\tilde{L}) = UT_n\left(\frac{2\Lambda}{\lambda_{\max}} - I\right)U^\top$$

Spectral Filters

Recall

$$T_0(x) = 1$$

$$T_1(x) = x$$

$$T_{n+1}(x) = 2xT_n(x) - T_{n-1}(x)$$

Let

$$T_n(\tilde{L}) = UT_n\left(\frac{2\Lambda}{\lambda_{\max}} - I\right)U^\top$$

We have

$$T_0(\tilde{L}) = I$$

$$T_1(\tilde{L}) = U\left(\frac{2\Lambda}{\lambda_{\max}} - I\right)U^\top = 2L/\lambda_{\max} - I$$

$$\begin{aligned} T_{n+1}(\tilde{L}) &= U\left(2\left(\frac{2\Lambda}{\lambda_{\max}} - I\right)T_n\left(\frac{2\Lambda}{\lambda_{\max}} - I\right) - T_{n-1}\left(\frac{2\Lambda}{\lambda_{\max}} - I\right)\right)U^\top \\ &= 2U\left(\frac{2\Lambda}{\lambda_{\max}} - I\right)U^\top UT_n\left(\frac{2\Lambda}{\lambda_{\max}} - I\right)U^\top - UT_{n-1}\left(\frac{2\Lambda}{\lambda_{\max}} - I\right)U^\top \\ &= 2\left(\frac{2L}{\lambda_{\max}} - I\right)T_n(\tilde{L}) - T_{n-1}(\tilde{L}) \end{aligned}$$

Spectral Filters

Recall

$$T_n(\tilde{L}) = UT_n\left(\frac{2\Lambda}{\lambda_{\max}} - I\right)U^\top$$

Spectral Filters

Recall

$$T_n(\tilde{L}) = UT_n\left(\frac{2\Lambda}{\lambda_{\max}} - I\right)U^\top$$

We have

$$\begin{aligned} h_\theta * X &\approx U\left(\sum_{n=0}^K \theta_n T_n\left(\frac{2\Lambda}{\lambda_{\max}} - I\right)\right)U^\top X \\ &= \sum_{n=0}^K \theta_n T_n(\tilde{L})X \end{aligned}$$

Spectral Filters

Recall

$$T_n(\tilde{L}) = UT_n\left(\frac{2\Lambda}{\lambda_{\max}} - I\right)U^\top$$

We have

$$\begin{aligned}h_\theta * X &\approx U\left(\sum_{n=0}^K \theta_n T_n\left(\frac{2\Lambda}{\lambda_{\max}} - I\right)\right)U^\top X \\ &= \sum_{n=0}^K \theta_n T_n(\tilde{L})X\end{aligned}$$

Let

$$T_0(\tilde{X}) = T_0(\tilde{L})X$$

Spectral Filters

Recall

$$T_n(\tilde{L}) = UT_n\left(\frac{2\Lambda}{\lambda_{\max}} - I\right)U^\top$$

We have

$$\begin{aligned} h_\theta * X &\approx U\left(\sum_{n=0}^K \theta_n T_n\left(\frac{2\Lambda}{\lambda_{\max}} - I\right)\right)U^\top X \\ &= \sum_{n=0}^K \theta_n T_n(\tilde{L})X \end{aligned}$$

Let

$$T_0(\tilde{X}) = T_0(\tilde{L})X$$

We have

$$\begin{aligned} T_0(\tilde{X}) &= X \\ T_1(\tilde{X}) &= 2LX/\lambda_{\max} - X \\ T_{n+1}(\tilde{X}) &= 2\left(\frac{2L}{\lambda_{\max}} - I\right)T_n(\tilde{X}) - T_{n-1}(\tilde{X}) \end{aligned}$$

Spectral Filters

Truncated Chebyshev polynomials based Graph Convolution:

$$h_\theta * X \approx \sum_{n=0}^K \theta_n T_n(\tilde{X})$$

where

$$T_0(\tilde{X}) = X$$

$$T_1(\tilde{X}) = 2LX/\lambda_{\max} - X$$

$$T_{n+1}(\tilde{X}) = 2 \left(\frac{2L}{\lambda_{\max}} - I \right) T_n(\tilde{X}) - T_{n-1}(\tilde{X})$$

Spectral Filters

Truncated Chebyshev polynomials based Graph Convolution:

$$h_\theta * X \approx \sum_{n=0}^K \theta_n T_n(\tilde{X})$$

where

$$T_0(\tilde{X}) = X$$

$$T_1(\tilde{X}) = 2LX/\lambda_{\max} - X$$

$$T_{n+1}(\tilde{X}) = 2 \left(\frac{2L}{\lambda_{\max}} - I \right) T_n(\tilde{X}) - T_{n-1}(\tilde{X})$$

What if we truncate to 1st order?

Spectral Filters

Truncated Chebyshev polynomials based Graph Convolution:

$$h_{\theta} * X \approx \sum_{n=0}^K \theta_n T_n(\tilde{X})$$

where

$$T_0(\tilde{X}) = X$$

$$T_1(\tilde{X}) = 2LX/\lambda_{\max} - X$$

$$T_{n+1}(\tilde{X}) = 2 \left(\frac{2L}{\lambda_{\max}} - I \right) T_n(\tilde{X}) - T_{n-1}(\tilde{X})$$

What if we truncate to 1st order?

That is Graph Convolutional Networks (GCNs) [8] !

Graph Convolutional Networks (GCNs)

Truncated Chebyshev polynomials based Graph Convolution:

$$h_{\theta} * X \approx \sum_{n=0}^K \theta_n T_n(\tilde{X})$$

$$T_0(\tilde{X}) = X$$

$$T_1(\tilde{X}) = 2LX/\lambda_{\max} - X$$

$$T_{n+1}(\tilde{X}) = 2 \left(\frac{2L}{\lambda_{\max}} - I \right) T_n(\tilde{X}) - T_{n-1}(\tilde{X})$$

Graph Convolutional Networks (GCNs)

Truncated Chebyshev polynomials based Graph Convolution:

$$h_{\theta} * X \approx \sum_{n=0}^K \theta_n T_n(\tilde{X})$$

$$h_{\theta} * X \approx \theta_0 X + \theta_1 T_1(\tilde{X})$$

$$T_0(\tilde{X}) = X$$

$$T_1(\tilde{X}) = 2LX/\lambda_{\max} - X$$

~~$$T_{n+1}(\tilde{X}) = 2 \begin{pmatrix} 2L & \\ \lambda_{\max} & I \end{pmatrix} T_n(\tilde{X}) - T_{n-1}(\tilde{X})$$~~

Graph Convolutional Networks (GCNs)

Truncated Chebyshev polynomials based Graph Convolution:

$$h_\theta * X \approx \sum_{n=0}^K \theta_n T_n(\tilde{X})$$

$$h_\theta * X \approx \theta_0 X + \theta_1 T_1(\tilde{X})$$

$$T_0(\tilde{X}) = X$$

$$T_1(\tilde{X}) = 2LX/\lambda_{\max} - X$$

~~$$T_{n+1}(\tilde{X}) = 2 \begin{pmatrix} 2L & \\ & I \end{pmatrix} T_n(\tilde{X}) - T_{n-1}(\tilde{X})$$~~

We can use the normalized graph Laplacian so that its eigenvalues are in $[0, 2]$

$$L = I - D^{-\frac{1}{2}} A D^{-\frac{1}{2}}$$

Graph Convolutional Networks (GCNs)

Truncated Chebyshev polynomials based Graph Convolution:

$$h_{\theta} * X \approx \sum_{n=0}^K \theta_n T_n(\tilde{X})$$

$$h_{\theta} * X \approx \theta_0 X + \theta_1 T_1(\tilde{X})$$

$$T_0(\tilde{X}) = X$$

$$T_1(\tilde{X}) = 2LX/\lambda_{\max} - X$$

~~$$T_{n+1}(\tilde{X}) = 2 \begin{pmatrix} 2L & \\ & I \end{pmatrix} T_n(\tilde{X}) - T_{n-1}(\tilde{X})$$~~

We can use the normalized graph Laplacian so that its eigenvalues are in $[0, 2]$

$$L = I - D^{-\frac{1}{2}} A D^{-\frac{1}{2}}$$

Assuming $\lambda_{\max} \approx 2$

$$h_{\theta} * X \approx \theta_0 X + \theta_1 T_1(\tilde{X})$$

$$\approx \theta_0 X - \theta_1 D^{-\frac{1}{2}} A D^{-\frac{1}{2}} X$$

Graph Convolutional Networks (GCNs)

Simplified Truncated Chebyshev polynomials based Graph Convolution:

$$\begin{aligned}h_{\theta} * X &\approx \theta_0 X + \theta_1 T_1(\tilde{X}) \\ &\approx \theta_0 X - \theta_1 D^{-\frac{1}{2}} A D^{-\frac{1}{2}} X \\ &= \theta \left(I + D^{-\frac{1}{2}} A D^{-\frac{1}{2}} \right) X\end{aligned}$$

Graph Convolutional Networks (GCNs)

Simplified Truncated Chebyshev polynomials based Graph Convolution:

$$\begin{aligned}h_{\theta} * X &\approx \theta_0 X + \theta_1 T_1(\tilde{X}) \\ &\approx \theta_0 X - \theta_1 D^{-\frac{1}{2}} A D^{-\frac{1}{2}} X \\ &= \theta \left(I + D^{-\frac{1}{2}} A D^{-\frac{1}{2}} \right) X\end{aligned}$$

$$I + D^{-\frac{1}{2}} A D^{-\frac{1}{2}}$$

eigenvalues are in $[0, 2]$

Graph Convolutional Networks (GCNs)

Simplified Truncated Chebyshev polynomials based Graph Convolution:

$$\begin{aligned}h_{\theta} * X &\approx \theta_0 X + \theta_1 T_1(\tilde{X}) \\ &\approx \theta_0 X - \theta_1 D^{-\frac{1}{2}} A D^{-\frac{1}{2}} X \\ &= \theta \left(I + D^{-\frac{1}{2}} A D^{-\frac{1}{2}} \right) X\end{aligned}$$

$$I + D^{-\frac{1}{2}} A D^{-\frac{1}{2}}$$

eigenvalues are in $[0, 2]$



$$\tilde{D}^{-\frac{1}{2}} (A + I) \tilde{D}^{-\frac{1}{2}}$$

$$\tilde{D}_{ii} = \sum_j (A + I)_{ij}$$

eigenvalues are in $[-1, 1]$

Graph Convolutional Networks (GCNs)

Simplified Truncated Chebyshev polynomials based Graph Convolution:

$$\begin{aligned}h_{\theta} * X &\approx \theta_0 X + \theta_1 T_1(\tilde{X}) \\ &\approx \theta_0 X - \theta_1 D^{-\frac{1}{2}} A D^{-\frac{1}{2}} X \\ &= \theta \left(I + D^{-\frac{1}{2}} A D^{-\frac{1}{2}} \right) X\end{aligned}$$

$$I + D^{-\frac{1}{2}} A D^{-\frac{1}{2}}$$

eigenvalues are in $[0, 2]$

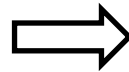

$$\tilde{D}^{-\frac{1}{2}} (A + I) \tilde{D}^{-\frac{1}{2}}$$

$$\tilde{D}_{ii} = \sum_j (A + I)_{ij}$$

eigenvalues are in $[-1, 1]$

Final Form of Graph Convolution:

$$h_{\theta} * X \approx \theta \tilde{D}^{-\frac{1}{2}} (A + I) \tilde{D}^{-\frac{1}{2}} X$$

Graph Convolutional Networks (GCNs)

Graph convolution in GCNs for 1D graph signal:

$$h_\theta * X \approx \theta \tilde{D}^{-\frac{1}{2}} (A + I) \tilde{D}^{-\frac{1}{2}} X$$

Graph Convolutional Networks (GCNs)

Graph convolution in GCNs for 1D graph signal:

$$h_\theta * X \approx \theta \tilde{D}^{-\frac{1}{2}} (A + I) \tilde{D}^{-\frac{1}{2}} X$$

Generalize to multi-input and multi-output convolution:

$$\begin{aligned} h_W * X &\approx \tilde{D}^{-\frac{1}{2}} (A + I) \tilde{D}^{-\frac{1}{2}} XW \\ &= \tilde{L}XW \end{aligned}$$

Graph Convolutional Networks (GCNs)

Graph convolution in GCNs for 1D graph signal:

$$h_\theta * X \approx \theta \tilde{D}^{-\frac{1}{2}} (A + I) \tilde{D}^{-\frac{1}{2}} X$$

Generalize to multi-input and multi-output convolution:

$$\begin{aligned} h_W * X &\approx \tilde{D}^{-\frac{1}{2}} (A + I) \tilde{D}^{-\frac{1}{2}} XW \\ &= \tilde{L}XW \end{aligned}$$

Add nonlinearity:

$$\sigma(h_W * X) \approx \sigma(\tilde{L}XW)$$

Graph Convolutional Networks (GCNs)

Our Spectral Filters are Localized:

$$\tilde{L} = \tilde{D}^{-\frac{1}{2}} (A + I) \tilde{D}^{-\frac{1}{2}}$$

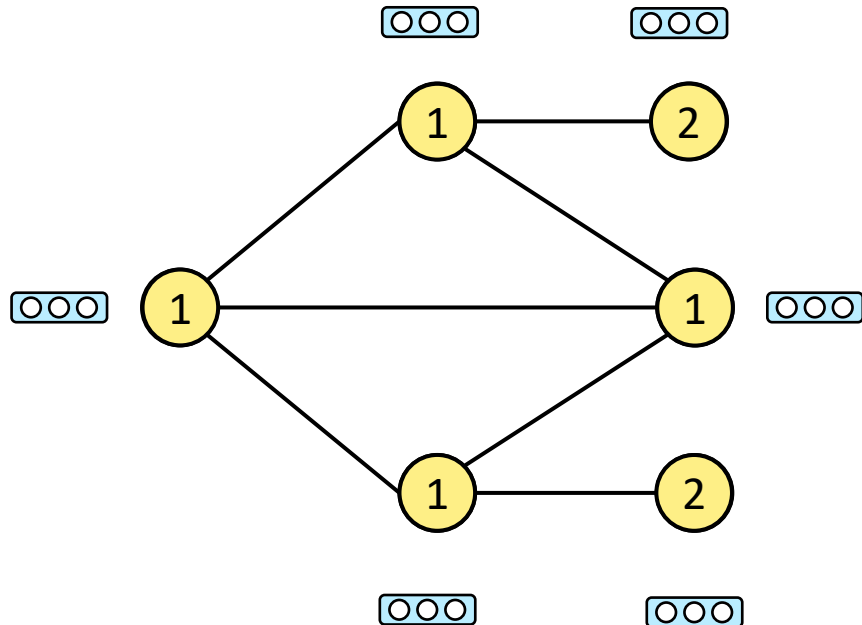

1-step Graph Convolution: $h_W * X \approx \tilde{L} X W$

2-step Graph Convolution: $h_{W_2} * h_{W_1} * X \approx \tilde{L}^2 X W_1 W_2$

⋮

Exponent of matrix power indicates how far the propagation is!

Graph Convolutional Networks (GCNs)

- We start with Chebyshev Polynomials which can represent any spectral filters (eigenvalues in $[-1, 1]$)

$$h(x) = \sum_{n=0}^{\infty} a_n T_n(x)$$

Graph Convolutional Networks (GCNs)

- We start with Chebyshev Polynomials which can represent any spectral filters (eigenvalues in $[-1, 1]$)

$$h(x) = \sum_{n=0}^{\infty} a_n T_n(x)$$

- Truncate the expansion at 1st order for efficiency

$$h_{\theta} * X \approx \theta_0 X + \theta_1 T_1(\tilde{X})$$

Graph Convolutional Networks (GCNs)

- We start with Chebyshev Polynomials which can represent any spectral filters (eigenvalues in $[-1, 1]$)

$$h(x) = \sum_{n=0}^{\infty} a_n T_n(x)$$

- Truncate the expansion at 1st order for efficiency

$$h_{\theta} * X \approx \theta_0 X + \theta_1 T_1(\tilde{X})$$

- Further simplification/approximation

$$h_{\theta} * X \approx \theta \tilde{D}^{-\frac{1}{2}} (A + I) \tilde{D}^{-\frac{1}{2}} X$$

$$h_W * X \approx \tilde{L} X W$$

Graph Convolutional Networks (GCNs)

- We start with Chebyshev Polynomials which can represent any spectral filters (eigenvalues in $[-1, 1]$)

$$h(x) = \sum_{n=0}^{\infty} a_n T_n(x)$$

- Truncate the expansion at 1st order for efficiency

$$h_{\theta} * X \approx \theta_0 X + \theta_1 T_1(\tilde{X})$$

- Further simplification/approximation

$$h_{\theta} * X \approx \theta \tilde{D}^{-\frac{1}{2}} (A + I) \tilde{D}^{-\frac{1}{2}} X$$

$$h_W * X \approx \tilde{L} X W$$

We can remedy the lost expressiveness by stacking multiple graph convolution layers!

Graph Convolutional Networks (GCNs)

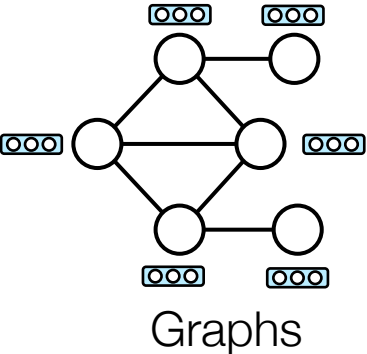

Graph Convolutional Networks (GCNs)

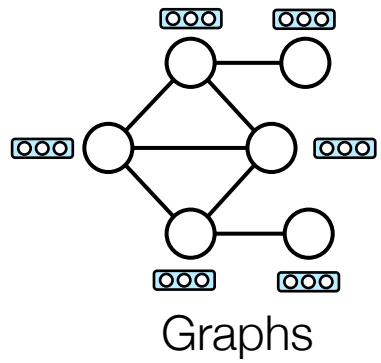

GraphConv

$$H_1 = \sigma(LXW_1)$$

Graph Convolutional Networks (GCNs)

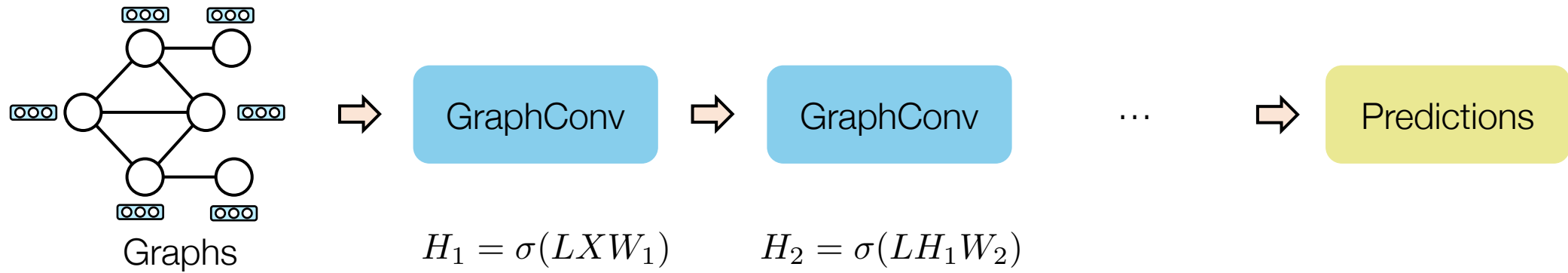

Message Passing GNNs

\mathbf{h}_i^t

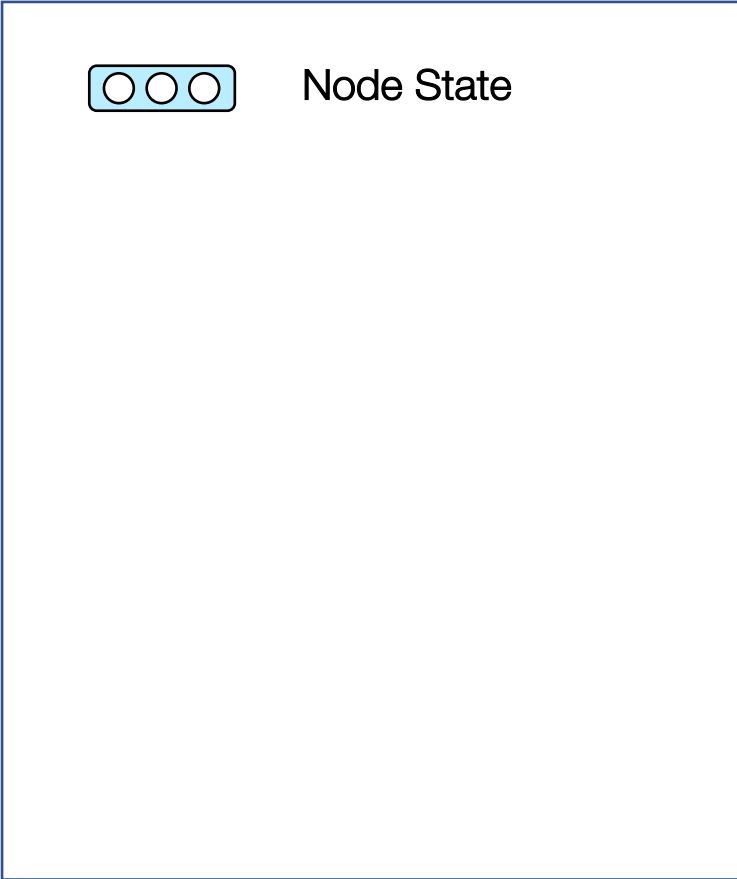

(t+1)-th message passing step/layer

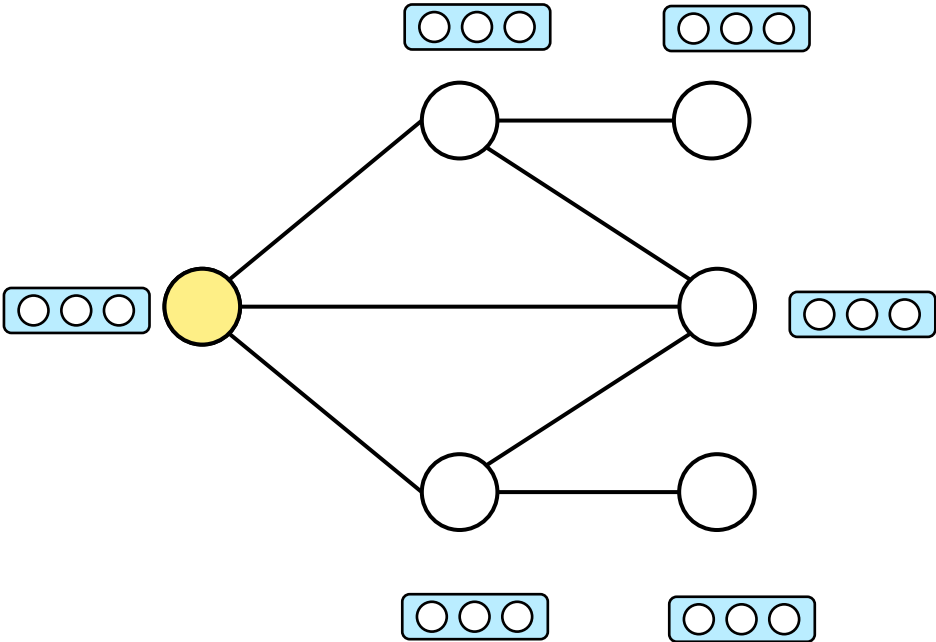

Message Passing GNNs

\mathbf{h}_i^t \mathbf{h}_j^t

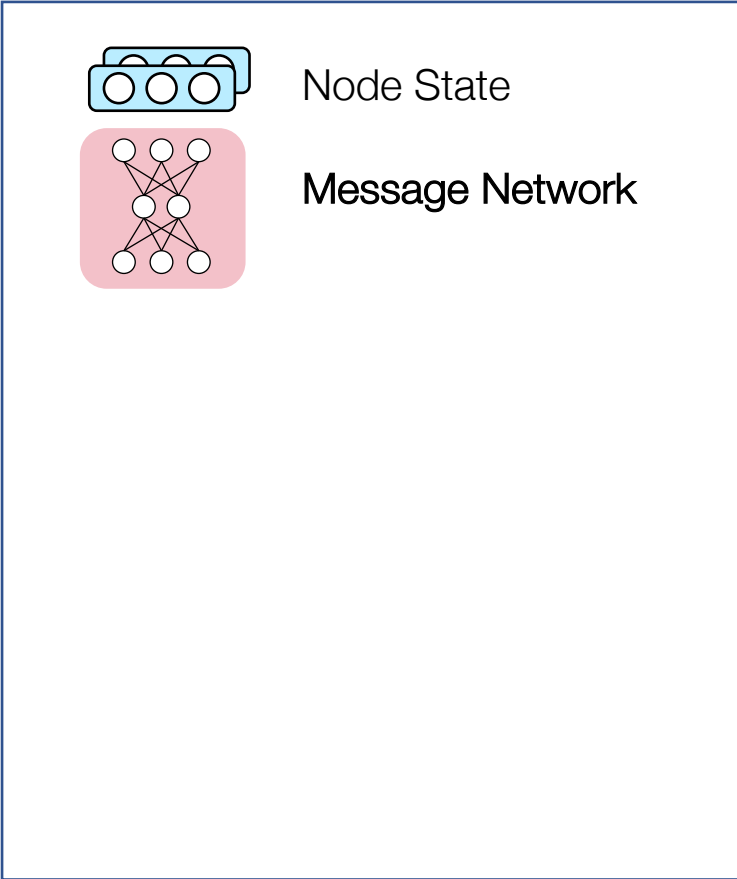

(t+1)-th message passing step/layer

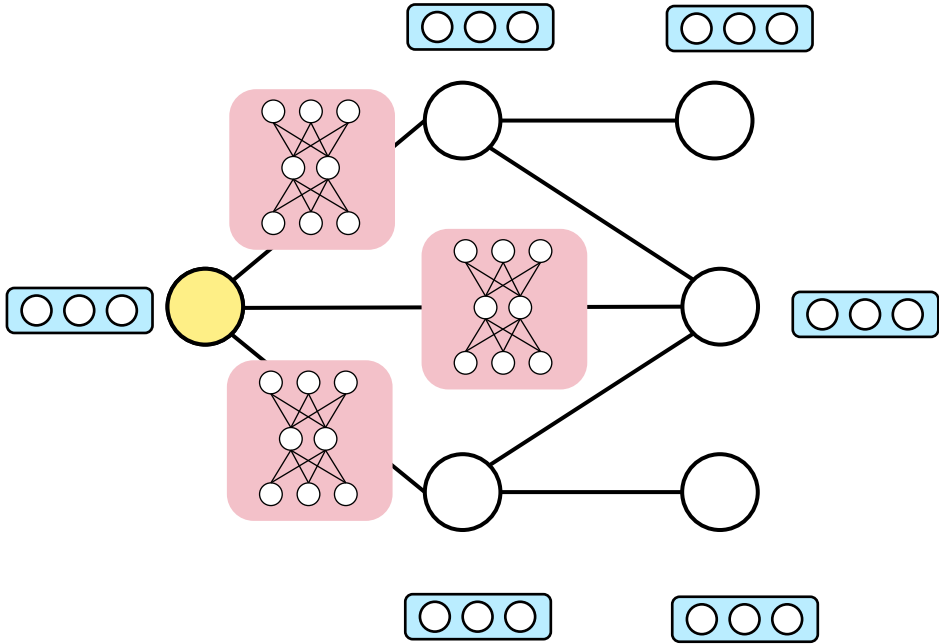

Message Passing GNNs

\mathbf{h}_i^t \mathbf{h}_j^t

$$\mathbf{m}_{ji}^t = f_{\text{msg}}(\mathbf{h}_j^t, \mathbf{h}_i^t)$$

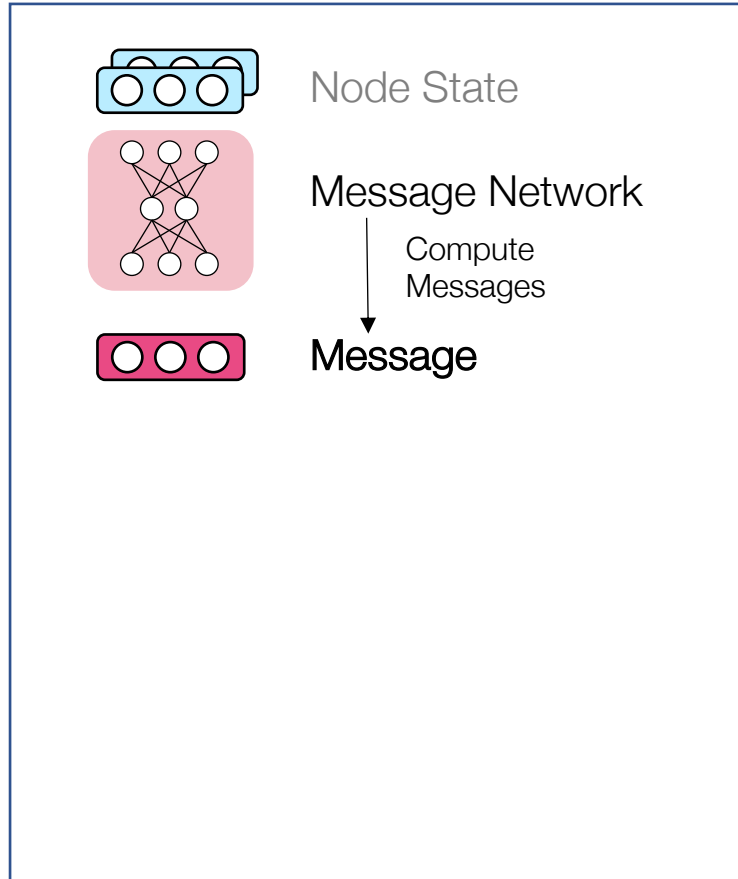

(t+1)-th message passing step/layer

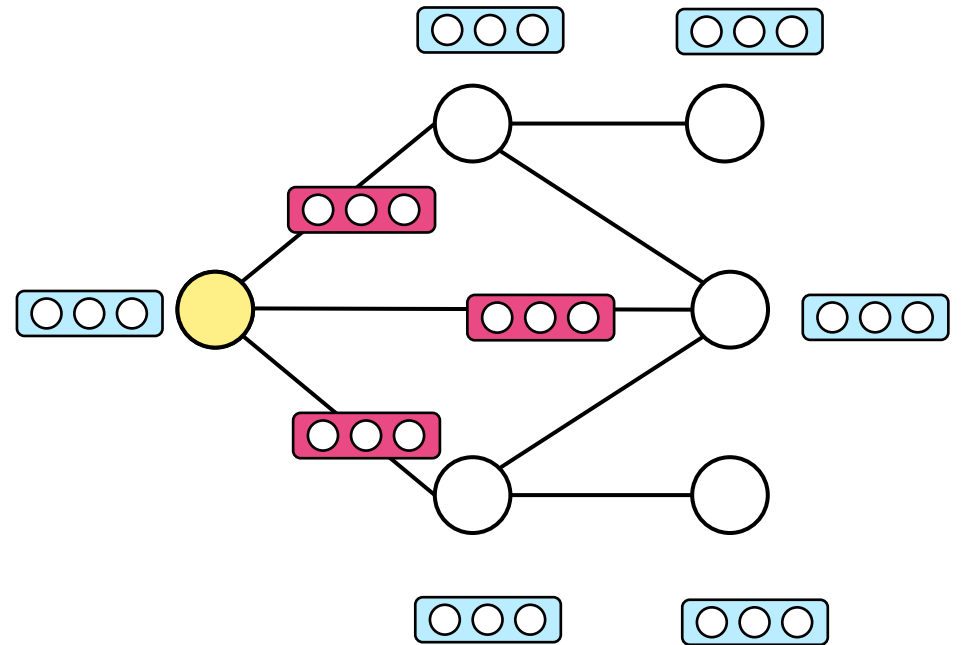

Message Passing GNNs

\mathbf{h}_i^t \mathbf{h}_j^t

$$\mathbf{m}_{ji}^t = f_{\text{msg}}(\mathbf{h}_j^t, \mathbf{h}_i^t)$$

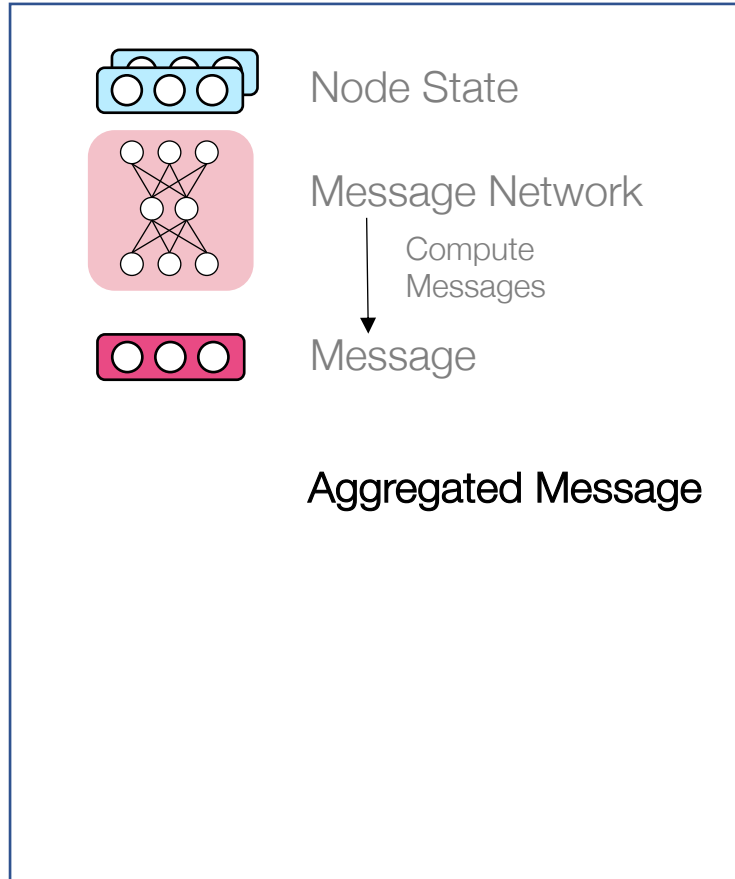

(t+1)-th message passing step/layer

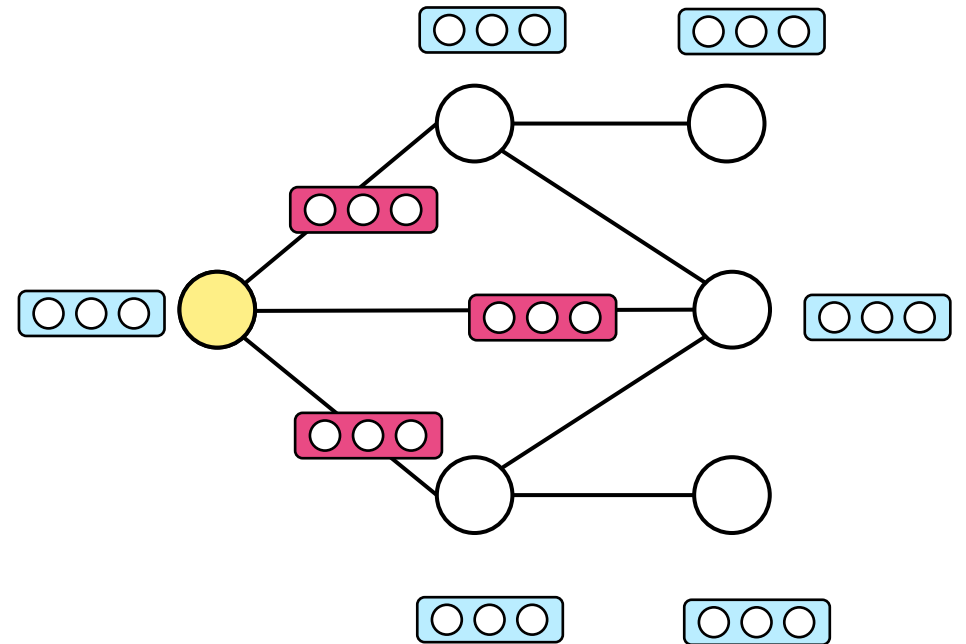

Message Passing GNNs

\mathbf{h}_i^t \mathbf{h}_j^t

$$\mathbf{m}_{ji}^t = f_{\text{msg}}(\mathbf{h}_j^t, \mathbf{h}_i^t)$$

$$\bar{\mathbf{m}}_i^t = f_{\text{agg}}(\{\mathbf{m}_{ji}^t | j \in \mathcal{N}_i\})$$

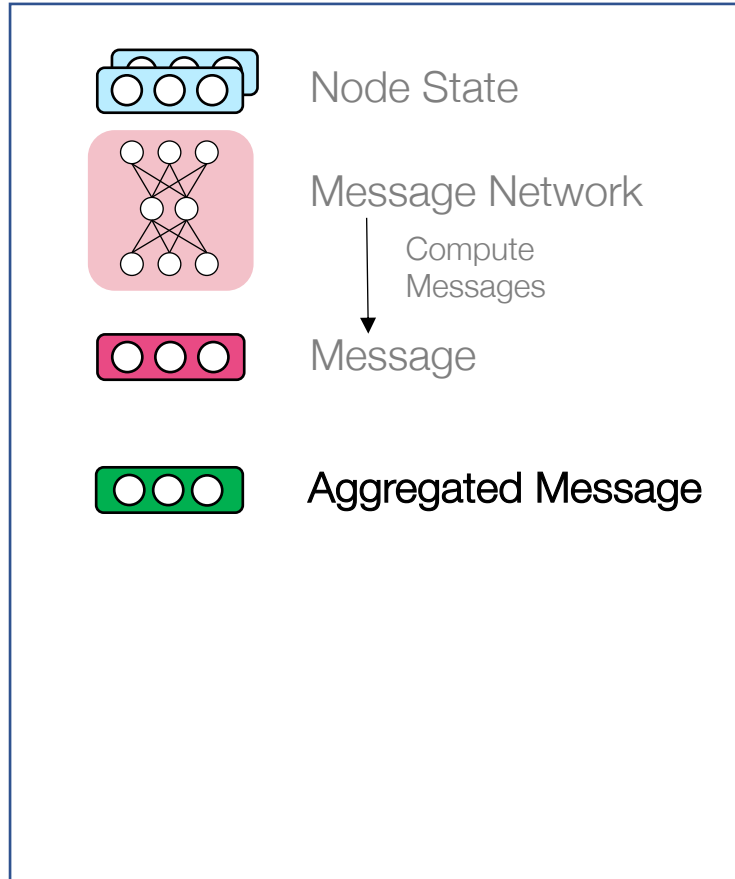

(t+1)-th message passing step/layer

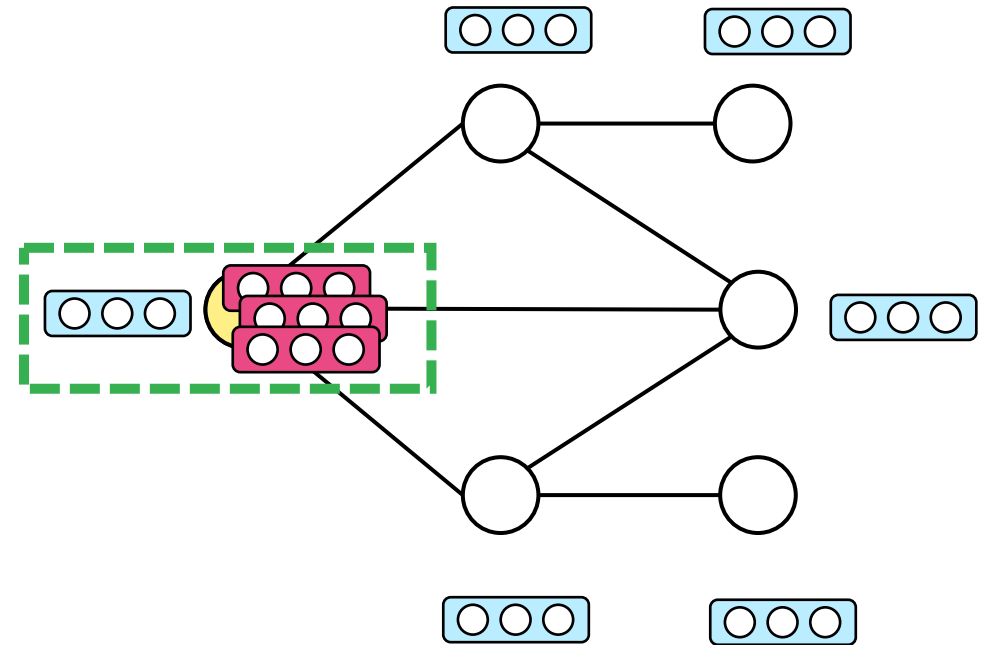

Message Passing GNNs

\mathbf{h}_i^t \mathbf{h}_j^t

$$\mathbf{m}_{ji}^t = f_{\text{msg}}(\mathbf{h}_j^t, \mathbf{h}_i^t)$$

$$\bar{\mathbf{m}}_i^t = f_{\text{agg}}(\{\mathbf{m}_{ji}^t | j \in \mathcal{N}_i\})$$

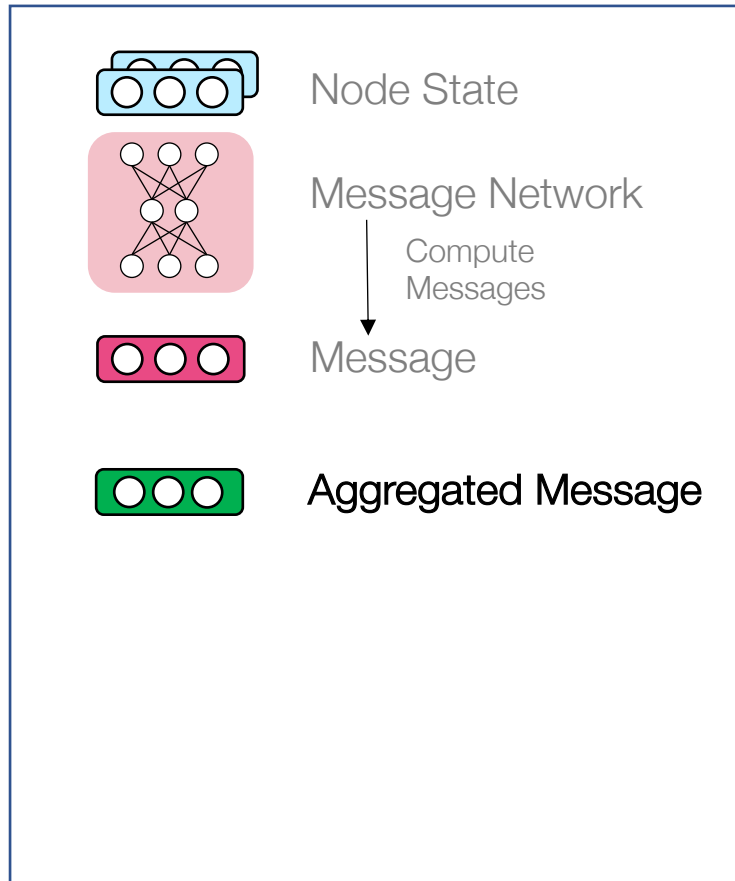

(t+1)-th message passing step/layer

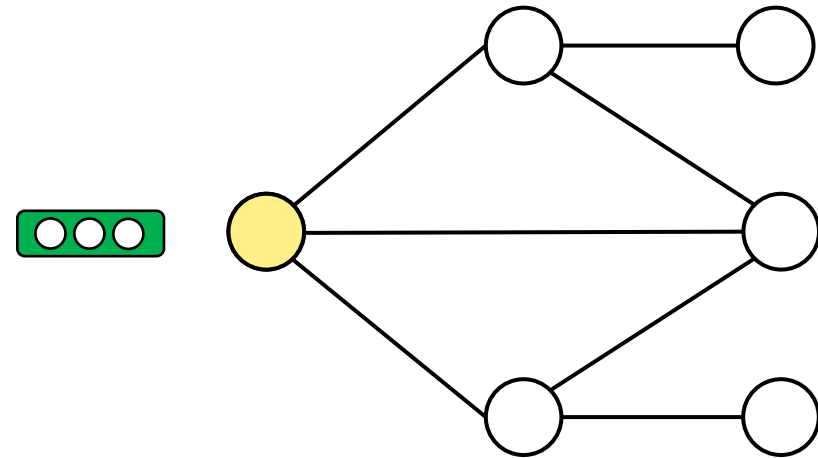

Message Passing GNNs

$$\mathbf{h}_i^t \quad \mathbf{h}_j^t$$

$$\mathbf{m}_{ji}^t = f_{\text{msg}}(\mathbf{h}_j^t, \mathbf{h}_i^t)$$

$$\bar{\mathbf{m}}_i^t = f_{\text{agg}}(\{\mathbf{m}_{ji}^t | j \in \mathcal{N}_i\})$$

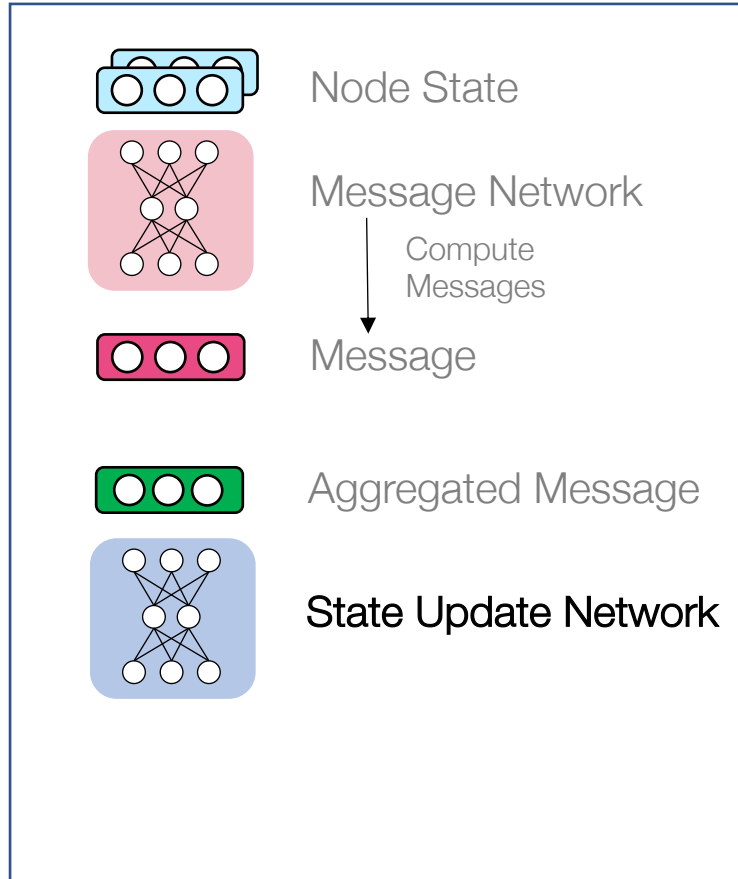

(t+1)-th message passing step/layer

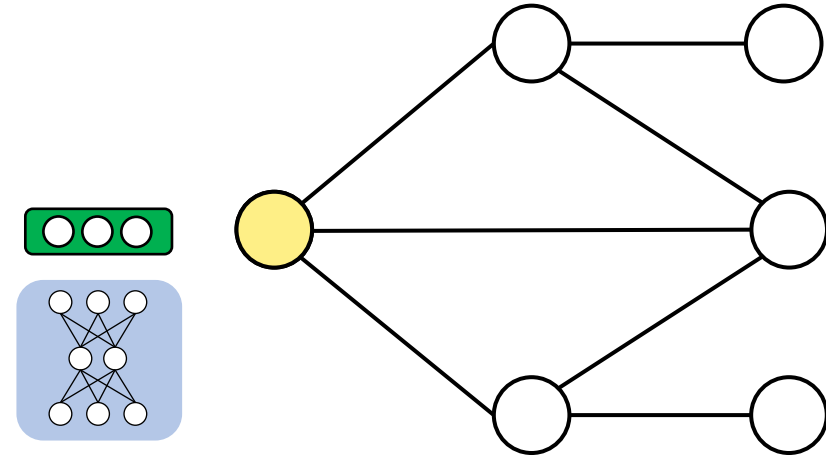

Message Passing GNNs

$$\mathbf{h}_i^t \quad \mathbf{h}_j^t$$

$$\mathbf{m}_{ji}^t = f_{\text{msg}}(\mathbf{h}_j^t, \mathbf{h}_i^t)$$

$$\bar{\mathbf{m}}_i^t = f_{\text{agg}}(\{\mathbf{m}_{ji}^t | j \in \mathcal{N}_i\})$$

$$\mathbf{h}_i^{t+1} = f_{\text{update}}(\mathbf{h}_i^t, \bar{\mathbf{m}}_i^t)$$

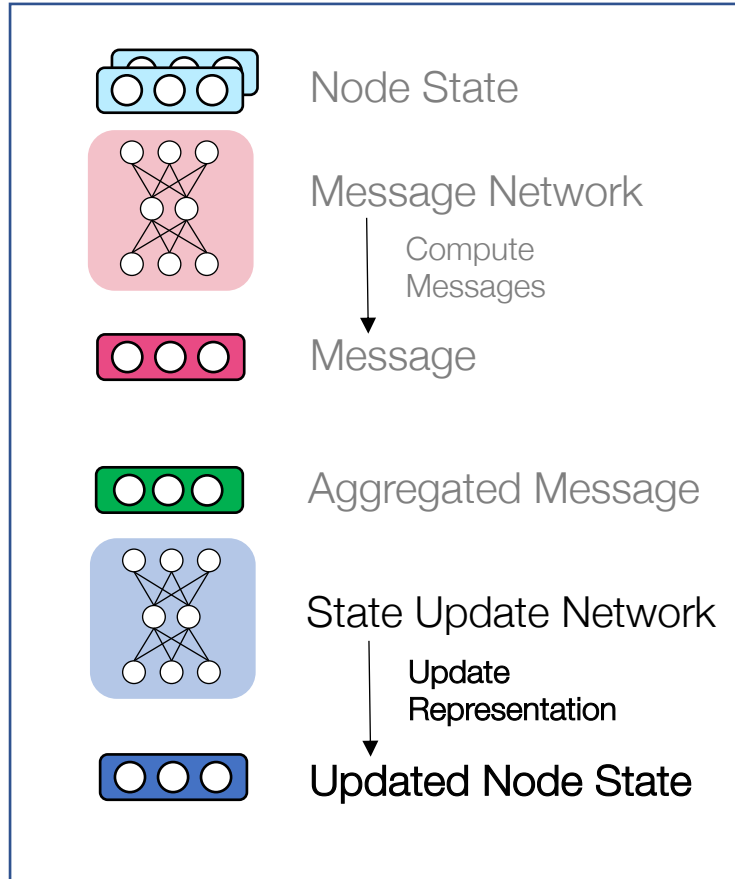

(t+1)-th message passing step/layer

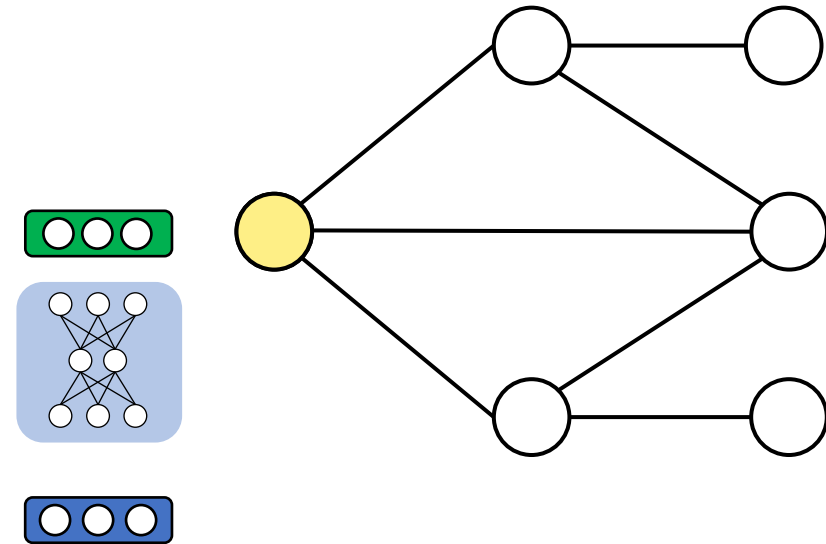

Message Passing GNNs

$$\mathbf{h}_i^t \quad \mathbf{h}_j^t$$

$$\mathbf{m}_{ji}^t = f_{\text{msg}}(\mathbf{h}_j^t, \mathbf{h}_i^t)$$

$$\bar{\mathbf{m}}_i^t = f_{\text{agg}}(\{\mathbf{m}_{ji}^t | j \in \mathcal{N}_i\})$$

$$\mathbf{h}_i^{t+1} = f_{\text{update}}(\mathbf{h}_i^t, \bar{\mathbf{m}}_i^t)$$

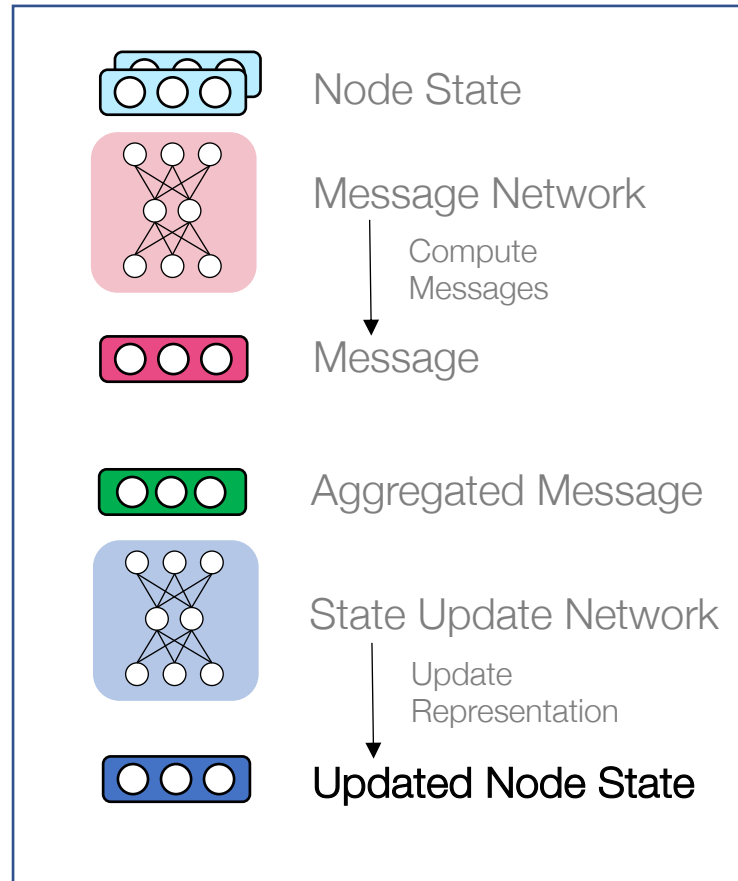

(t+1)-th message passing step/layer

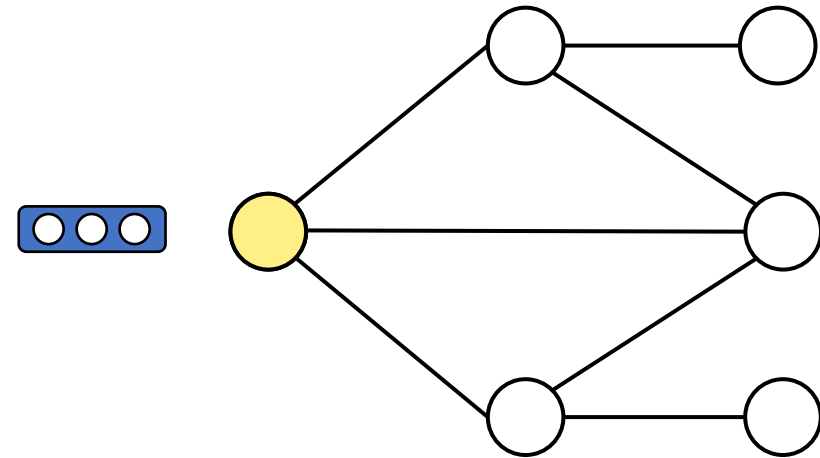

GCNs are Message Passing Networks

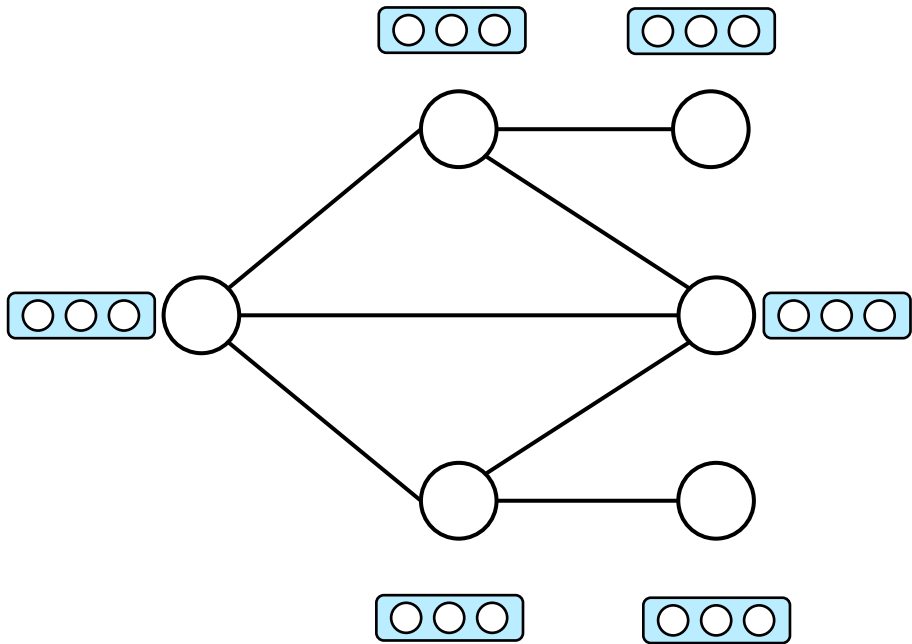

- Node State X

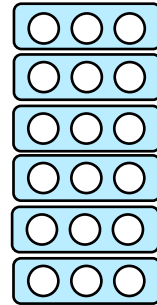

- Graph Laplacian

$$\tilde{L} = \tilde{D}^{-\frac{1}{2}} (A + I) \tilde{D}^{-\frac{1}{2}}$$

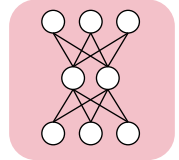

GCNs are Message Passing Networks

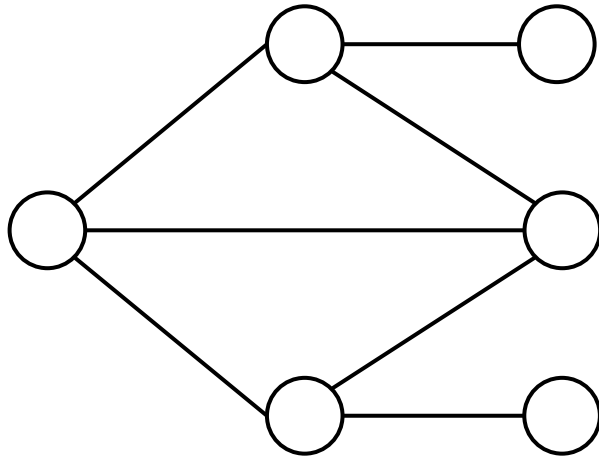

- Node State X

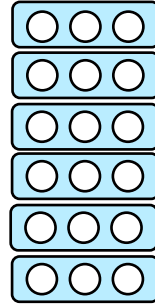

- Aggregated Message

$$\tilde{L}X$$

- Graph Laplacian

$$\tilde{L} = \tilde{D}^{-\frac{1}{2}}(A + I)\tilde{D}^{-\frac{1}{2}}$$

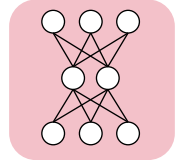

- State Update Network W

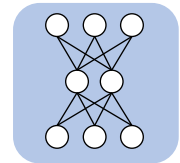

Revisit Spectral Filtering

Our Spectral Filters are Localized:

$$\tilde{L} = \tilde{D}^{-\frac{1}{2}} (A + I) \tilde{D}^{-\frac{1}{2}}$$

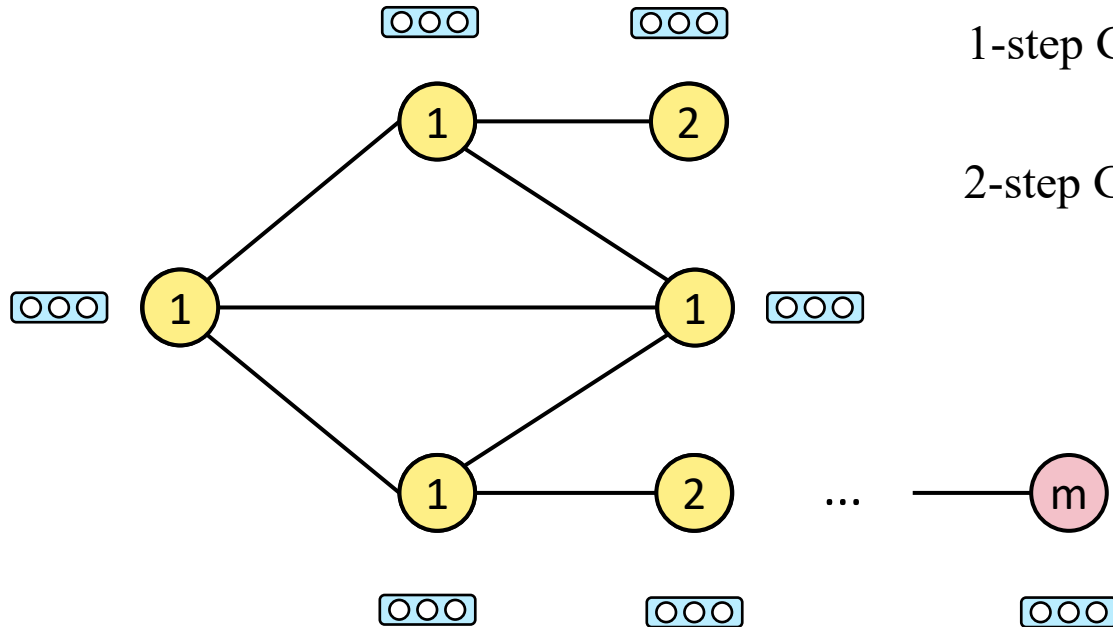

1-step Graph Convolution: $h_W * X \approx \tilde{L}XW$

2-step Graph Convolution: $h_{W_2} * h_{W_1} * X \approx \tilde{L}^2 XW_1W_2$

What if the graph diameter m is large?

Revisit Spectral Filtering

Our Spectral Filters are Localized:

m-step Graph Convolution:

$$h_W * X \approx \tilde{L}^m X W$$

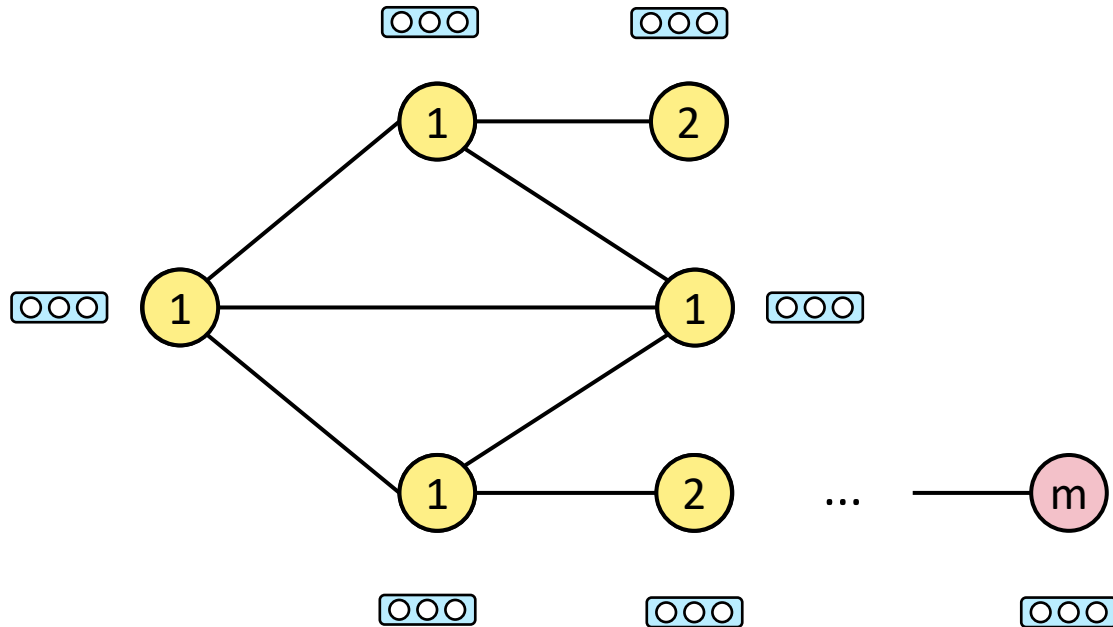

Revisit Spectral Filtering

Our Spectral Filters are Localized:

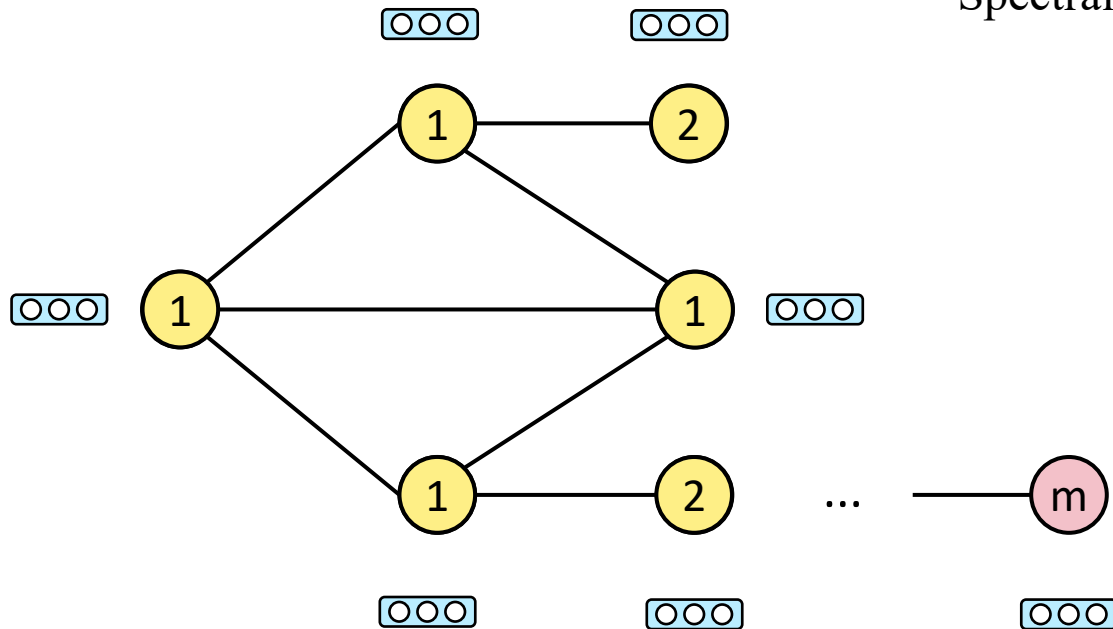

m-step Graph Convolution:

$$h_W * X \approx \tilde{L}^m X W$$

Spectral Decomposition:

$$\tilde{L} = U \Lambda U^\top$$

$$\tilde{L}^m = U \Lambda^m U^\top$$

Revisit Spectral Filtering

Our Spectral Filters are Localized:

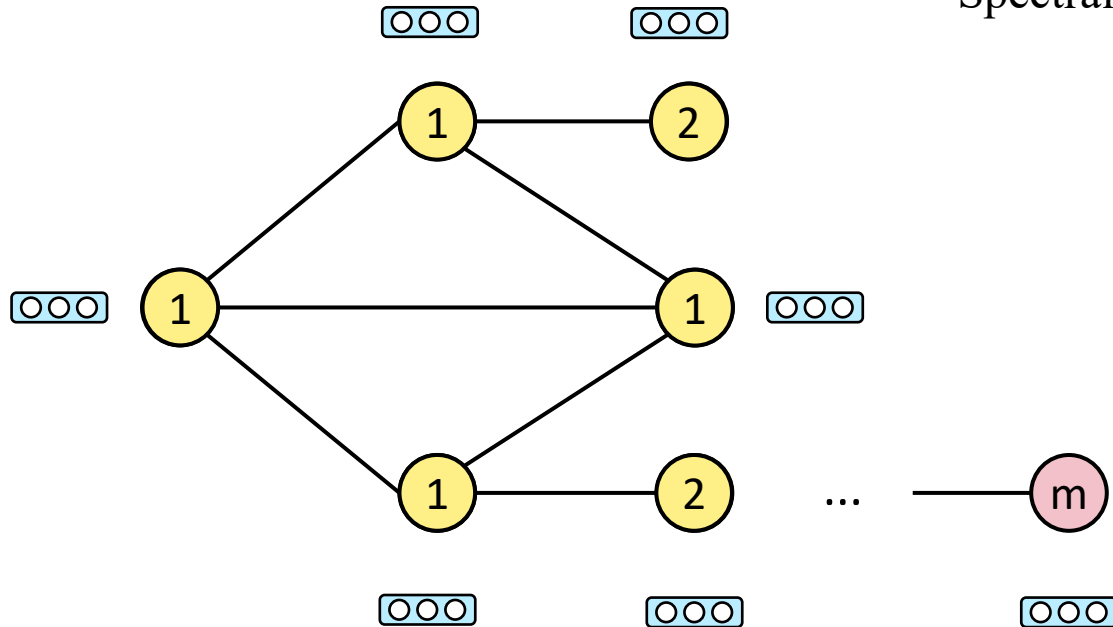

m-step Graph Convolution:

$$h_W * X \approx \tilde{L}^m X W$$

Spectral Decomposition:

$$\tilde{L} = U \Lambda U^\top$$

$$\tilde{L}^m = U \Lambda^m U^\top$$

Cubic complexity $O(N^3)$!

Lanczos Algorithm

Algorithm 1 : Lanczos Algorithm

- 1: **Input:** S, x, K, ϵ
 - 2: **Initialization:** $\beta_0 = 0, q_0 = 0$, and $q_1 = x/\|x\|$
 - 3: **For** $j = 1, 2, \dots, K$:
 - 4: $z = Sq_j$
 - 5: $\gamma_j = q_j^\top z$
 - 6: $z = z - \gamma_j q_j - \beta_{j-1} q_{j-1}$
 - 7: $\beta_j = \|z\|_2$
 - 8: **If** $\beta_j < \epsilon$, **quit**
 - 9: $q_{j+1} = z/\beta_j$
 - 10:
 - 11: $Q = [q_1, q_2, \dots, q_K]$
 - 12: Construct T following Eq. (2)
 - 13: Eigen decomposition $T = BRB^\top$
 - 14: Return $V = QB$ and R .
-

Lanczos Algorithm

Tridiagonal Decomposition

$$L = QTQ^T$$

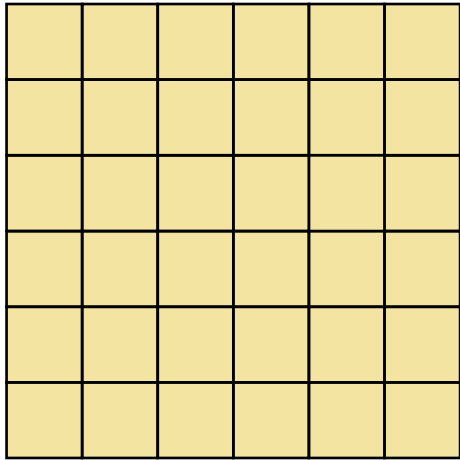

L

=

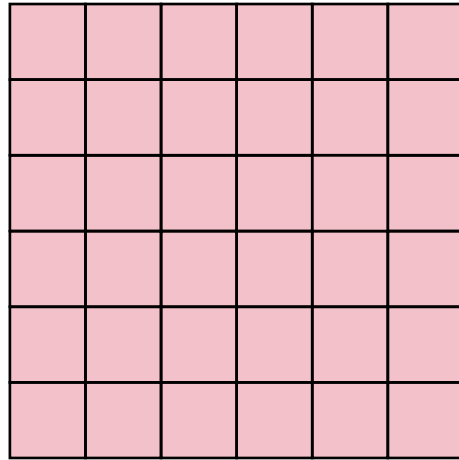

Q

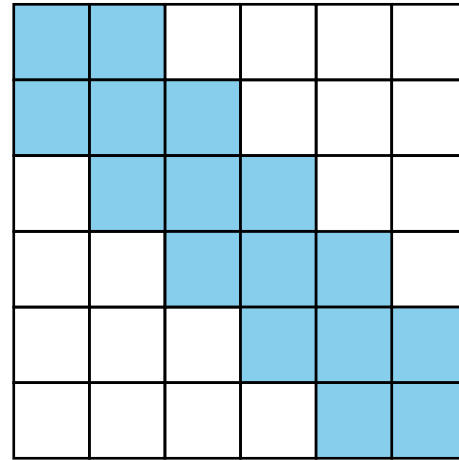

T

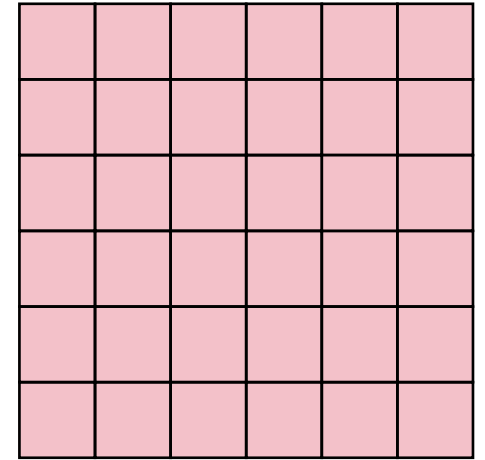

Q^T

Lanczos Algorithm

Tridiagonal Decomposition

$$L = QTQ^T$$

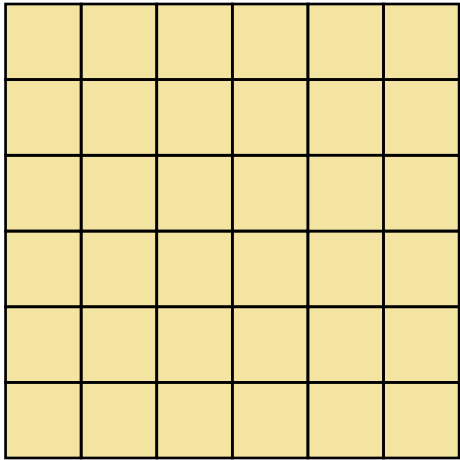

L

=

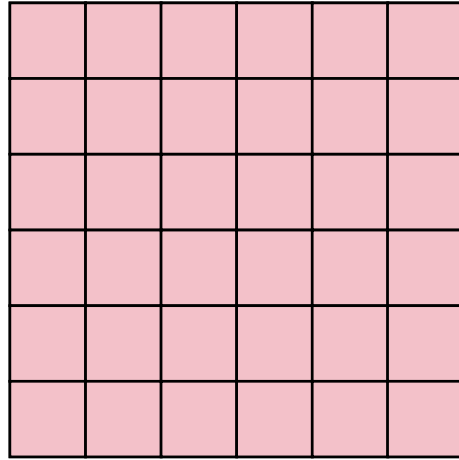

Q

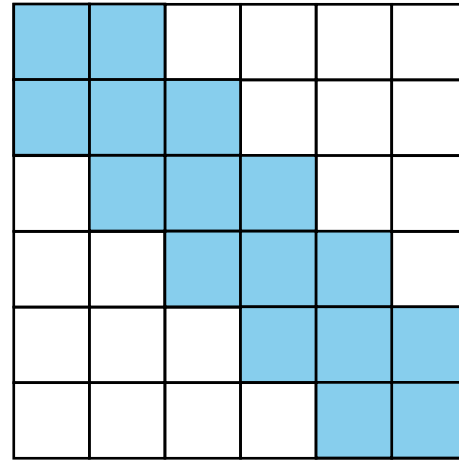

T

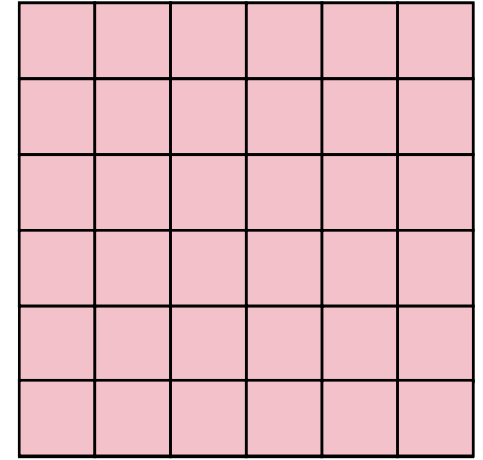

Q^T

Lanczos Algorithm

Tridiagonal Decomposition

$$L = QTQ^T$$

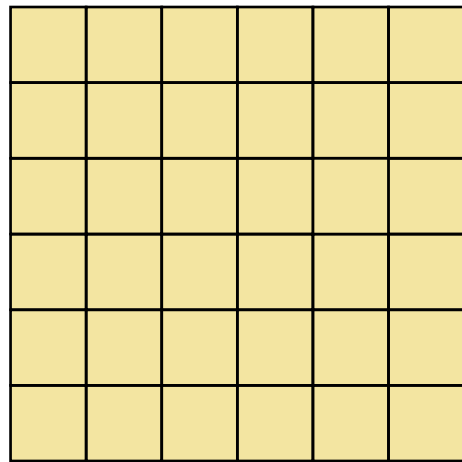

L

=

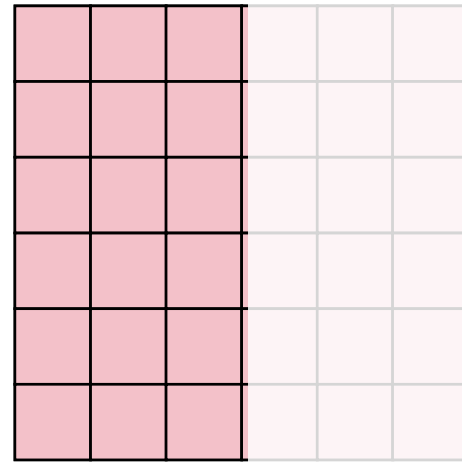

Q

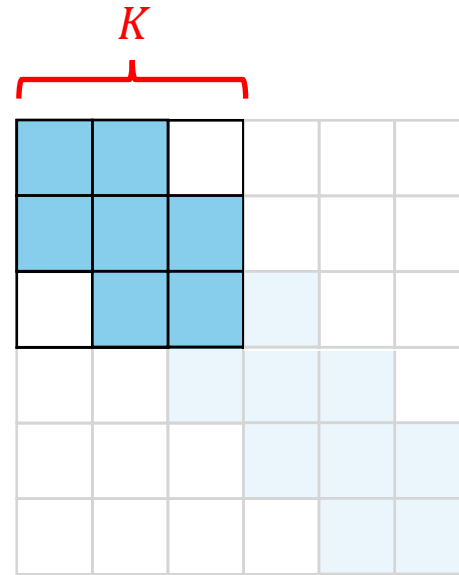

T

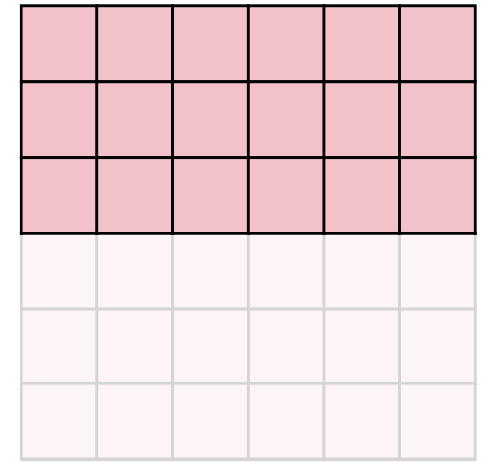

Q^T

Lanczos Algorithm

Tridiagonal Decomposition

Low-rank approximation

$$L = QTQ^T$$

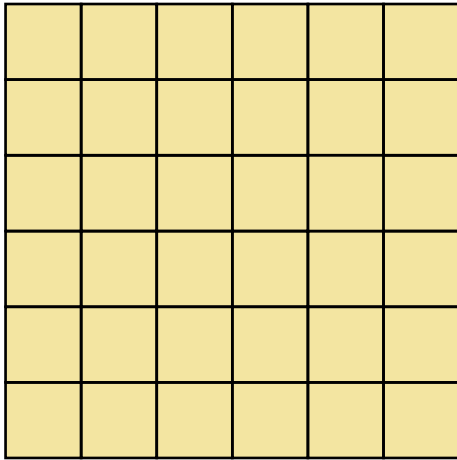

L

\approx

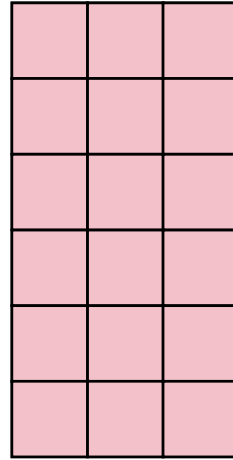

Q

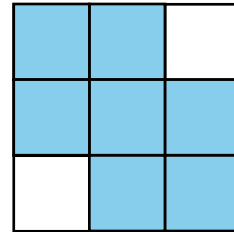

T

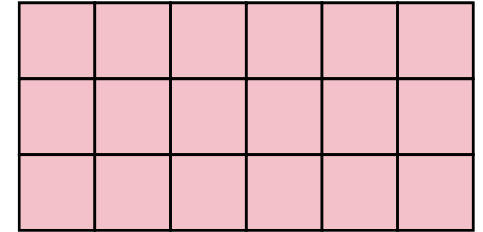

Q^T

Lanczos Algorithm

Tridiagonal Decomposition $L = QTQ^\top$

Low-rank approximation with **top K eigenpairs**

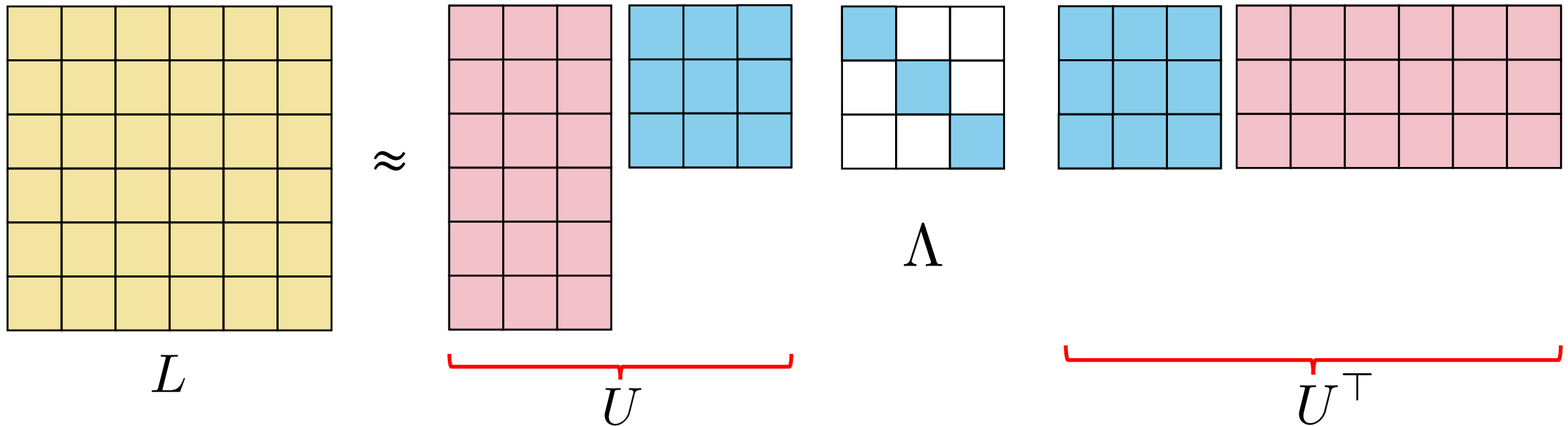

$O(N^3)$ \rightarrow $O(KN^2)$

Multi-scale Graph Convolutional Networks

- m-step GraphConv (Prior Work)

$$H = L^m XW$$

LanczosNet [9]:

- m-step GraphConv

$$H = U \Lambda^m U^\top XW$$

- Learn Nonlinear Spectral Filter

$$H = U \boxed{f_\theta}(\Lambda^m) U^\top XW$$

- Learning Graph Kernel / Metric

$$L_{ij} \propto \exp(-\|(X_i - X_j) \boxed{M}\|^2)$$

References

- [1] Scarselli, F., Gori, M., Tsoi, A.C., Hagenbuchner, M. and Monfardini, G., 2008. The graph neural network model. *IEEE transactions on neural networks*, 20(1), pp.61-80.
- [2] Goller, C. and Kuchler, A., 1996, June. Learning task-dependent distributed representations by backpropagation through structure. In *Proceedings of International Conference on Neural Networks (ICNN'96)* (Vol. 1, pp. 347-352). IEEE.
- [3] Ackley, D.H., Hinton, G.E. and Sejnowski, T.J., 1985. A learning algorithm for Boltzmann machines. *Cognitive science*, 9(1), pp.147-169.
- [4] Shuman, D.I., Narang, S.K., Frossard, P., Ortega, A. and Vandergheynst, P., 2013. The emerging field of signal processing on graphs: Extending high-dimensional data analysis to networks and other irregular domains. *IEEE signal processing magazine*, 30(3), pp.83-98.
- [5] Ortega, A., Frossard, P., Kovačević, J., Moura, J.M. and Vandergheynst, P., 2018. Graph signal processing: Overview, challenges, and applications. *Proceedings of the IEEE*, 106(5), pp.808-828.
- [6] Bronstein, M.M., Bruna, J., LeCun, Y., Szlam, A. and Vandergheynst, P., 2017. Geometric deep learning: going beyond euclidean data. *IEEE Signal Processing Magazine*, 34(4), pp.18-42.
- [7] Hammond, D.K., Vandergheynst, P. and Gribonval, R., 2011. Wavelets on graphs via spectral graph theory. *Applied and Computational Harmonic Analysis*, 30(2), pp.129-150.
- [8] Kipf, T.N. and Welling, M., 2016. Semi-supervised classification with graph convolutional networks. *arXiv preprint arXiv:1609.02907*.
- [9] Liao, R., Zhao, Z., Urtasun, R. and Zemel, R.S., 2019. Lanczosnet: Multi-scale deep graph convolutional networks. *arXiv preprint arXiv:1901.01484*.

Questions?